

## **Intersection Control Evaluation (ICE) Summary Report**

# **Holman Highway (SR 68) Widening Project – Phase 2**

Monterey, California

July 2013

## Intersection Control Evaluation (ICE) Summary Report

# Holman Highway (SR 68) Widening Project – Phase 2

Monterey, California

Prepared For:

**City of Monterey**  
580 Pacific Street  
Monterey, CA 93940  
(831) 646-3885

Prepared By:

**Kittelson & Associates, Inc.**  
428 J Street, Suite 500  
Sacramento, California 95814  
(916) 226-2190

Project Manager: Sean Houck, P.E.

Project Principal: Brian Ray, P.E.

Project No. 13023

July 2013



---

SEAN T. HOUCK P.E., Registered Civil Engineer

July 8, 2013

DATE

# TABLE OF CONTENTS

Table of Contents .....	iii
Executive Summary .....	2
Project Description .....	4
Project Status .....	5
Funding .....	6
Source of Roundabout Concept .....	6
Community Interaction .....	7
Existing Conditions .....	9
Existing Geometric Features .....	9
Traffic Data .....	9
Collision Data .....	11
Land Use .....	11
Route Concept and Corridor Vision .....	11
Bicycle Route .....	12
Pedestrian Considerations .....	12
Design Vehicle .....	12
Alternatives .....	14
Roundabout Intersection Alternative .....	14
Traffic Signal Intersection Alternative .....	15
Operations .....	22
2015 Operations .....	22
2030 Operations .....	24
Future Investment Needed to Extend Service Life .....	25
Life-Cycle Cost .....	26
Geometrics and Other Design Considerations .....	30
Guide Signing .....	30
Truck Accommodation .....	31
Safety Characteristics .....	32
Bicycle and Pedestrian Accommodation .....	33
Non-Conforming Features .....	36
Approved Design Exceptions .....	36
Deviations from HDM Design Standards .....	36



---

Nonconforming Roundabout Features.....	37
Recommendations .....	39



## LIST OF FIGURES

Figure 1	Vicinity Map .....	5
Figure 2	Traffic Signal Alternative – SR 1 Southbound On-Ramp Configuration .....	16
Figure 3	2015 Traffic Scenario Roundabout Configuration .....	17
Figure 4	2030 Traffic Scenario Roundabout Configuration .....	18
Figure 5	2015 Traffic Scenario Signal Configuration .....	19
Figure 6	2030 Traffic Scenario Signal Configuration .....	20
Figure 7	2015 Traffic Signal Alternative – Southbound Off-Ramp Queue.....	23

## LIST OF TABLES

Table 1	Traffic Volume Scenarios – SR 68 at SR 1 Southbound Ramp Termini .....	10
Table 2	Traffic Volume Scenarios – Pebble Beach Gate at SR 1 Southbound On-Ramp .....	10
Table 3	Historical Crash Data Summary .....	11
Table 4	2015 Traffic Operations Comparison – SR 68 at SR 1 Southbound Ramp Termini.....	22
Table 5	Performance Comparison – 2015 Operations .....	24
Table 6	2030 Traffic Operation Comparison – SR 68 at SR 1 Southbound Ramp Termini .....	24
Table 7	Performance Comparison – 2030 Operations .....	25
Table 8	Performance Comparison – Future Investment Needs .....	26
Table 9	Performance Comparison – Life Cycle Costs .....	28
Table 10	Performance Comparison – Guide Signing .....	31
Table 11	Performance Comparison – Truck Accommodation.....	32
Table 12	Performance Comparison – Safety Characteristics .....	33
Table 13	Performance Comparison – Pedestrian and Bicycle Accommodations.....	34
Table 14	Alternatives Performance Comparison.....	39

## ATTACHMENTS

Attachment A Traffic Volumes

Attachment B Monterey County Bicycle Maps

Attachment C Roundabout Performance Checks

Attachment D Signal Operations Analysis

Attachment E Roundabout Operations Analysis

Attachment F Guide Signing Concepts

Attachment G Design Vehicle Checks

Section 1  
Executive Summary

## EXECUTIVE SUMMARY

The City of Monterey conducted this Intersection Control Evaluation (ICE) to objectively evaluate two alternatives for the intersection control form at the SR 68 (Holman Highway)/SR 1 Ramp Termini intersection. The two alternatives evaluated were a traffic signal and a roundabout.

The evaluation was based primarily on traffic operations (2015 and 2030) including service life and life cycle cost considerations, as well as geometrics and other design considerations. Key findings include:

- The roundabout intersection alternative was found to perform better than the traffic signal alternative in almost all criteria.
- The operations of the traffic signal were found to be unacceptable in the 2015 and 2030 design years
- The 4-lane widening of SR 68 is required to accommodate the proposed ultimate 2030 traffic signal configuration.
- The roundabout alternative can be constructed independently of the future 4-lane widening of SR 68.

The geometric design and safety considerations favored the roundabout alternative. The roundabout was found to accommodate all traffic movements for the design vehicle, where the traffic signal limits some movements for trucks. The roundabout alternative allows for less complex guide signing through the intersection, where the traffic signal requires specific lane designations to reach destinations in the eastbound and southbound directions. Additionally, the roundabout alternative has better expected safety performance than the traffic signal alternative.

Based on the results, the City of Monterey recommends the roundabout alternative be moved forward as the preferred alternative for the SR 68/SR 1 Southbound Ramp Termini intersection. As the roundabout alternative is moved forward into PS&E, the City of Monterey will look for opportunities to coordinate with Caltrans and other agencies to refine and optimize the proposed concepts within the project contextual environment.

Section 2  
Project Description

## PROJECT DESCRIPTION

This Intersection Control Evaluation (ICE) compares and evaluates alternatives for the intersection control of SR 68 (Holman Highway) with the SR 1 Southbound Ramps. The general location of the intersection is shown on the vicinity map in Figure 1. This ICE is a supplement to the Project Report (PR) performed for the Holman Highway Widening Project, which evaluated alternatives for SR 68 from the Community Hospital of Monterey Peninsula (CHOMP) to the SR 68/SR 1 Junction. The preferred alternative from the PR is a full four-lane widening of SR 68 with a five-legged signalized intersection at the SR 68/SR 1 Ramp Termini.

The approved PR for the Holman Highway Widening Project outlined that project will be constructed in three separate phases as follows:

- Phase 1 would construct CHOMP improvements at the SR 68 and CHOMP entrance intersection. This intersection improvement is required as part of the mitigation for the CHOMP expansion.
- Phase 2 would construct the southbound on-ramp and modify the Pebble Beach Entrance. This improvement is required as part of the mitigation for the Pebble Beach Development Project.
- Phase 3 would be the remainder of the project, which the City of Monterey will take the lead and will be the agency responsible for final design and construction.

This ICE is meant to further explore intersection control alternatives at the SR 68/SR 1 Ramp Termini intersection for implementation in Phase 2 of the project as outlined below.

Two project alternatives are described in this ICE:

- Signalized Intersections
- Roundabout Intersections

**Figure 1 Vicinity Map**

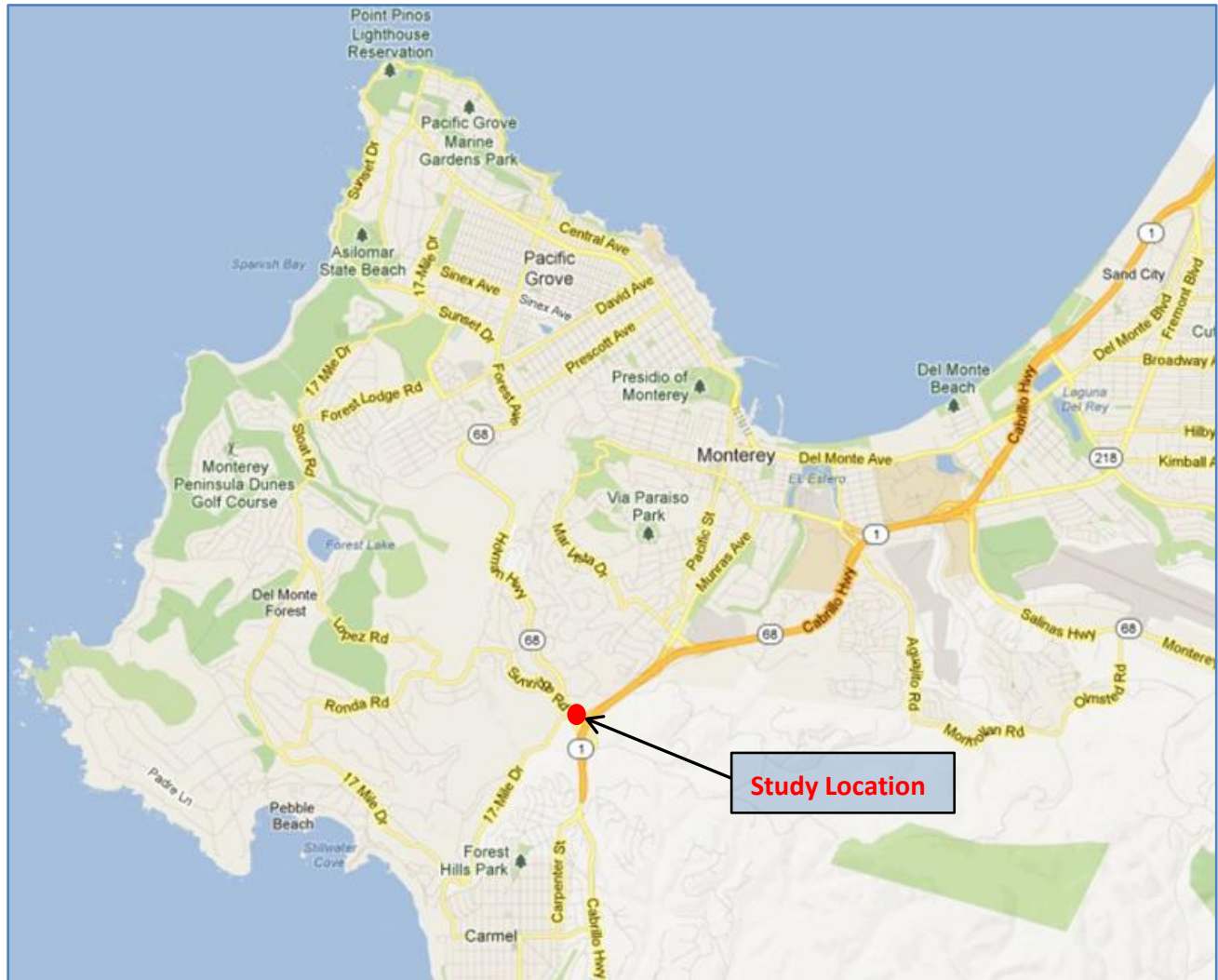

## PROJECT STATUS

The Project Report (PR) was approved in March 2009 for the signal alternative identified in the Holman Highway Widening Project (RU-06-234 EA 448000).

Phase 1 of the project has been constructed as part of the mitigations for the CHOMP expansion.

Phase 2 of the project is scheduled for construction in 2015.

Phase 3 of the project is not funded and a timeline for construction is unknown at this time.

At this time, a Roundabout Report of Conceptual Approval will be required for consideration of each roundabout alternative in the project report. However, the review and approval process for roundabouts on the state highway system will likely be changed in the Summer of 2013.

A Supplemental Project Report will serve as approval of the “selected” alternative.

Subsequent to the PR approval, a Final Environmental Impact Report for Pebble Beach Company projects was approved April 2012. The roundabout concept for Phase 2 improvements was identified as a mitigation measure.

## FUNDING

Phase 2 of the Holman Highway Widening Project is funded by Pebble Beach Company (PBC) as part of the mitigation for the Pebble Beach Development Project. The estimated share of PBC funds from the PR was \$1,705,000. Currently, PBC's share is approximately \$4,000,000.

Additional funding for the roundabout alternative is provided through an AB 2766 grant from the Monterey Bay Unified Air Pollution Control District (MBUAPCD) to the City of Monterey and the Transportation Authority for Monterey County (TAMC). The City of Monterey grant is \$350,000 for plan preparation and approval. The TAMC grant is \$50,000 for outreach and education. The MBUAPCD grants can only be used for the development, approval, and construction of the roundabout alternative.

The capital outlay support, right-of-way, and construction components of the project are preliminary estimates.

## SOURCE OF ROUNDABOUT CONCEPT

The basis for the roundabout concept presented in this report was identified through a feasibility study led by the City of Monterey and prepared by Parsons Brinckerhoff between 2011 and 2012. The study was wholly funded by an AB 2766 grant awarded by the Monterey Unified Air Pollution Control District (MBUAPCD). Roundabout operations, footprint, and pollutant emissions were determined and compared to the existing conditions and the signal improvements described in the PR. The following conclusions were made during the feasibility study:

- The roundabout is a feasible form of intersection control;
- Roundabout operations will reduce delay and queues;
- The roundabout alternative will have a smaller footprint and fewer impacts to the surrounding environment; and
- The roundabout alternative will result in fewer pollutant emissions.

The roundabout concept was identified in the Pebble Beach Company Project Final Environmental Impact Report dated April 2012 as a traffic mitigation project.

The roundabout concepts presented in this report are refinements to the roundabout concept developed in the feasibility study. The refinements were generated by Kittelson & Associates, Inc. (KAI) in January through March 2013 based on operational analysis and feedback from the City of Monterey and Caltrans.



## COMMUNITY INTERACTION

City of Monterey, Transportation Agency for Monterey County (TAMC), Caltrans, CHOMP and PBC have conducted coordination on improvements to SR 68 in the project area, resulting in significant community approval on moving forward intersection and corridor improvements. In particular, coordination has taken place in January through March of 2013 to move potential roundabout concepts forward for consideration at the CHOMP and SR 1 Ramp intersections with SR 68.

Specific public outreach items that have taken place with regard to this project are as follows:

- Presentation to the TAMC Technical Advisory Committee (TAC);
- Stakeholder meeting at TAMC including; Presidio of Monterey, Monterey County, City of Pacific Grove, City of Monterey, Pebble Beach Company, Caltrans, TAMC, and Monterey Bay Unified Air Pollution Control District (MBUAPCD);
- Two presentations to CHOMP staff;
- Presentation to City of Pacific Grove staff;
- Presentation to professional organizations including the planning association, APWA, and CSPE (civil engineering group);
- Presentation on the local Monterey channel on the "Your Town" show
- Two presentations to the MBUAPCD board;
- Local television reports (twice);
- Presentation to a subcommittee of the County Board of Supervisors; and
- The project has received Monterey City Council approvals for contract approval, grant applications, and intent to annex.

All of the public outreach and community involvement activities listed above had outcomes that can be characterized as favorable to the project.

In addition to community interaction, three ICE workshops were held with Caltrans through the alternatives evaluation and documentation process. The first workshop was held on January 31, 2013 and presented the project approach and outline, and solicited feedback from Caltrans to refine the scope of the evaluation. The second ICE workshop was held on February 19, 2013 and presented the preliminary findings of the evaluation and solicited feedback from Caltrans. The third ICE workshop was held in March 26, 2013 and presented the final findings and recommendations of the ICE.

Section 3  
Existing Conditions

## EXISTING CONDITIONS

### EXISTING GEOMETRIC FEATURES

SR 68 (Holman Highway) is a two-lane undivided conventional highway constructed in the early 1940s. It serves as the primary transportation facility between SR 1 and the City of Pacific Grove, Pebble Beach, and CHOMP.

The portion of SR 68 between CHOMP and SR 1 was upgraded with improved radii and superelevation in the mid-1950s when this portion of the highway was designated as part of SR 68 with the posted speed limit of 35 mph. The cross-section for SR 68 consists of two 12-foot lanes with shoulder widths ranging from 2 feet to 4 feet. The design speed within the project limit is 35 mph. SR 68 is part of the California Legal Truck Route and SR 1 is a Terminal Access (STAA) facility.

The SR 68/SR 1 southbound ramp configuration is a diamond off-ramp and on-ramp. The southbound on-ramp begins approximately 250 feet south of the SR 68/SR 1 off-ramp intersection. Between SR 68 and the beginning of the southbound on-ramp is a two-way roadway providing access to Pebble Beach. The Pebble Beach entrance forms a T-intersection with this two-way roadway, allowing the eastbound approach to make both left- and right-turn movements.

Improvements to this portion of SR 68 are constrained by the existing facilities adjacent to the highway. These facilities include the entrance to Pebble Beach 17 Mile Drive toll gate, Beverley Manor Development, CHOMP entrance, Sunridge Road, Scenic Drive overcrossing of SR 68, and the existing SR 68 overcrossing of SR 1. The topography within the study area was also identified as a constraint, since the land on the south side of SR 68 falls away steeply toward the Pebble Beach area.

### TRAFFIC DATA

Existing and future traffic volumes were provided by the City of Monterey and are based on the volumes used in the Del Monte Forest Plan (DMFP), prepared by Fehr & Peers in August 2011. The existing year traffic counts were collected in April 2011.

The 2011 traffic counts were compared to the 2003 traffic counts used in the approved PR for the Holman Highway Widening Project. The total entering 2011 volumes at the SR 68/SR 1 Ramp intersection were found to be approximately 5.5% less in the AM peak hour and 10% less in the PM peak hour than were counted in 2003. In general, the primary reduction in traffic between 2003 and 2011 was found to be on the northbound and southbound legs of the intersection. Additionally, the 2011 traffic counts were also found to be slightly lower than the forecasted 2010 traffic volumes presented in the PR for the Holman Highway Widening Project.

The traffic volume scenarios analyzed for 2015 and 2030 include future growth based on changes of land use, planned development, and anticipated growth within the region. The DMFP Alternative 1

traffic generation volumes were incorporated into the traffic volumes for all scenarios, as directed by the City of Monterey. Alternative 1 of the DMFP assumed the inclusion of traffic associated with the Spyglass Hotel in addition to the other land uses included in the trip generation estimates. The traffic scenarios analyzed for this ICE are as follows:

- 2011 with DMFP Alternative 1 traffic;
- 2015 with DMFP Alternative 1 traffic; and
- 2030 with DMFP Alternative 1 traffic (without POM traffic)

The above scenarios are the same that were analyzed in the DMFP, with the exception of the 2030 volumes which were modified to eliminate the traffic volumes associated with Presidio of Monterey.

Table 1 presents the traffic volumes used in each scenario for the analysis of the SR 68/SR 1 Ramp Termini intersection. The volumes for the individual traffic movements have been isolated based on the approved five-legged traffic signal configuration to show the volumes destined to the SR 1 southbound on-ramp and those destined for Pebble Beach/17 Mile Drive. Table 2 presents the traffic volumes used in each scenario for analyzing the Pebble Beach Gate/SR 1 SB On-Ramp intersection.

Traffic volume worksheets with the traffic scenarios presented above are provided in Attachment A.

**Table 1 Traffic Volume Scenarios – SR 68 at SR 1 Southbound Ramp Termini**

Approach Leg	Movement	2011 + DMFP Alt 1		2015 + DMFP Alt 1		2030 + DMFP Alt 1	
		AM	PM	AM	PM	AM	PM
Northbound (SR 1 On-Ramp/ Pebble Beach Entrance)	LT	36	33	44	37	44	37
	RT	210	388	217	400	237	440
Westbound (SR 68)	LT to Ramp	7	7	10	10	10	10
	LT to PB	71	62	79	70	79	70
	Thru	363	380	376	393	415	443
Southbound (SR 1 Off-Ramp)	LT	12	9	20	10	20	20
	Thru	448	248	460	254	510	284
	RT	592	704	617	730	673	800
Eastbound (SR 68)	Thru	671	628	688	647	768	723
	RT to Ramp	352	365	373	376	402	415
	RT to PB	22	23	17	25	27	25

**Table 2 Traffic Volume Scenarios – Pebble Beach Gate at SR 1 Southbound On-Ramp**

Approach Leg	Movement	2011 + DMFP Alt 1		2015 + DMFP Alt 1		2030 + DMFP Alt 1	
		AM	PM	AM	PM	AM	PM
Eastbound (Pebble Beach Exit)	LT	246	421	261	437	281	477
	RT	46	132	48	89	59	99
Southbound (SR 1 On-Ramp)	Thru	359	372	383	386	412	425
	RT	541	333	556	349	616	379

## COLLISION DATA

No new historical collision data was collected for this ICE. The approved PR for the Holman Highway Widening Project presented collision rates on SR 68 and SR 1 for the three-year period from October 1, 2001 through September 30, 2004, and are provided in Table 3 below. The collision data is based on Caltrans Traffic Accident Surveillance and Analysis System (TASAS) – Transportation Systems Network (TSN).

**Table 3 Historical Crash Data Summary**

Facility	Total Crashes	Fatal	Fatal + Injury	Actual Crash Rate (crashes/million veh-miles)			Statewide Average Crash Rate (crashes/million veh-miles)		
				Total	Fatal	Fatal + Injury	Total	Fatal	Fatal + Injury
SR 68 (2.26-L4.25)	134	2	43	2.46	0.037	0.79	1.55	0.035	0.67
SR 1 (74.56 – R75.98)	168	0	57	1.83	0.00	0.62	1.16	0.012	0.45

The crash data from 2001-2004 indicates that crash rates were higher than the statewide averages at the time, including for fatal crashes on SR 68. Two fatalities were recorded on SR 68 in the study area in the three years of data; however, the specific locations of the fatalities are not known.

## LAND USE

The existing land uses along SR 68 within the project limits consist of single-family residential abutting the south side of SR 68 and primarily commercial and institutional land uses on the north side of SR 68. CHOMP, Carmel Hills Care Center and Carmel Hills Professional Center are the primary developments that make up the land uses on the north side of SR 68. There are two driveway entrances (CHOMP entrance and the combined Carmel Hills Care Center and Carmel Hills Professional Center entrance) with left-turn channelization. The CHOMP entrance to SR 68 is signalized.

## ROUTE CONCEPT AND CORRIDOR VISION

SR 68 serves as the primary transportation facility between SR 1 and the City of Pacific Grove, Pebble Beach, and CHOMP. Additionally, the intersection of SR 68 and SR 1 serves as a key access point to these destinations. The Pebble Beach gate at the intersection of 17 Mile Drive and the SR 1 southbound on-ramp is one of five gates accessing Pebble Beach and the Del Monte Forest.

The Holman Highway is an integral peninsula transportation link as one of two ways to access Pacific Grove. The City of Monterey fundamentally wishes to preserve the integrity of this vital multimodal transportation link. The City recognizes the land use and transportation context around the Holman Highway has changed over the years, creating the need to re-define the character and use of the roadway. For the segment between CHOMP and SR 1, this future context and character will evolve to a more suburban form consistent with land uses and driver expectation.

---

## BICYCLE ROUTE

SR 68 from SR 1 to Pacific Grove is classified as a Caltrans Bike Route in the TAMC Monterey County 2011 Bike Map. The segment of SR 68 in the study area currently has paved shoulders of varying widths that accommodate bicycles. SR 68 is identified in the TAMC Bicycle and Pedestrian Master Plan (December 2011) to be a Class II bike facility with bike lanes in the future.

A Class I multi-use path facility currently runs along the east side of SR 1 from SR 68 to Viejo Road. The Class I multi-use path facility is identified in the TAMC Bicycle and Pedestrian Master Plan to extend south of SR 68 along SR 1 in the future. The multi-use path system ties in with SR 68 on the east side of the SR 68 overcrossing of SR 1.

Bicycle Network Maps from the TAMC Bicycle and Pedestrian Master Plan are included in Attachment B.

## PEDESTRIAN CONSIDERATIONS

No continuous pedestrian facilities currently exist along SR 68 through the study area. No signalized pedestrian crossings are currently provided at the signalized intersection of SR 68 and SR 1 Ramp Termini. An existing sidewalk connection is provided along the west side of Beverley Manor to a bus stop located at the northwest corner of the intersection of Beverley Manor and SR 68.

## DESIGN VEHICLE

SR 68 is part of the California Legal Truck Network and SR 1 is a Terminal Access (STAA) facility. Thus, the ramp terminal intersection of SR 68 with SR 1 must accommodate the STAA-Standard truck as the design vehicle. The design vehicle on SR 68 west of the SR 1 Ramp Termini intersection is a California Truck.

The Pebble Beach gate entrance from the SR 1 southbound on-ramp south of SR 68 is the primary entrance to Pebble Beach and 17 Mile Drive for STAA vehicles and other large delivery vehicles in support of special events. Thus, the alternatives considered in this ICE were evaluated for their ability to accommodate the design vehicles into the Pebble Beach gate.

Section 4  
Alternatives

## ALTERNATIVES

Two alternatives were evaluated as part of this ICE. The alternatives focused on the intersection control form for the SR 68 intersection with the SR 1 southbound ramps. Because of the close spacing between SR 68 and the Pebble Beach gates, the alternatives encompassed the whole segment south of SR 68 to the Pebble Beach gates. The two alternatives evaluated are a roundabout intersection and a five-legged signalized intersection.

The primary distinctions between the two alternatives are:

1. Intersection control form; and
2. Location of the entrance to SR 1 southbound on-ramp.

### ROUNABOUT INTERSECTION ALTERNATIVE

The roundabout intersection alternative would replace the existing intersection control with a roundabout at the SR 68/SR 1 Ramp Termini intersection, and a partial roundabout at the Pebble Beach Gate/SR 1 Southbound Ramp intersection. The roundabout alternatives were developed for the 2015 and 2030 traffic scenarios and are shown in Figures 3 and 4, respectively.

The roundabout concepts shown in Figures 3 and 4 are the same for the two scenarios, since the configuration needed to accommodate traffic in 2015 accommodates traffic expected in 2030.

#### Roundabout Performance Checks

Performance checks were completed for the roundabout concept in addition to the design vehicle checks described above. The performance checks document the safe and efficient operations of a roundabout, and include checking fastest paths, vehicle speeds and speed consistency, vehicle path alignment, and stopping and intersection sight distance.

#### *Fastest Path and Vehicle Speed Checks*

The fastest paths allowed by the geometry determines the negotiation speed for the particular movement into, through, and exiting the roundabout. The paths represent the theoretical attainable entry speeds for design purposes. The controlling radii of the paths through the roundabout are used to determine the theoretical speeds for those radii. The fastest paths were drawn for each approach of the 2015 Interim roundabout alternative and vehicle speeds estimated from those paths. The paths and calculation worksheets are provided in Attachment C.

The proposed roundabout achieves the target safety performance as outlined in NCHRP Report 687 *Roundabouts: An Informational Guide*.



### **Vehicle Path Alignment**

The natural vehicle paths through a roundabout are the paths approaching vehicles will naturally take through the roundabout geometry, assuming there is traffic in all approach lanes. For a roundabout with multiple entry lanes, the alignment of the natural vehicle paths should minimize conflicts or the overlap of these paths entering or exiting the roundabout. The desired result of the entry design is for vehicles to naturally be aligned into their correct lane within the circulatory roadway. This concept was applied to the 2015 Interim roundabout concept to ensure desirable entry geometry. A sketch showing the alignment of the natural entry paths is provided in Attachment C.

The proposed roundabout achieves the desired vehicle path alignment performance as outlined in NCHRP Report 687 *Roundabouts: An Informational Guide*.

### **Sight Distance**

The approach speeds determined through the fastest path checks were used to determine the required stopping and intersection sight distance at the roundabout approaches and within the roundabout. Stopping sight distance should be provided at every point within a roundabout and on each entering and exiting approach. The intersection sight distance is the distance required for a driver without the right-of-way to perceive and react to the presence of conflicting vehicles, and is achieved through the establishment of sight triangles at the roundabout entries. The stopping and intersection sight distance triangles were overlaid onto the 2015 Interim roundabout concept to illustrate the clear vision areas for the intersection. These clear vision areas help establish the appropriate locations for various types of landscaping or other treatments. The sight distance diagram is provided in Attachment C.

The proposed roundabout provides adequate stopping and intersection sight distance for the forecast operating speeds.

## **TRAFFIC SIGNAL INTERSECTION ALTERNATIVE**

The traffic signal intersection alternative would modify the existing traffic signal and intersection configuration at the SR 68/southbound SR 1 Ramp Termini. The alternative would create a five-legged intersection by separating the entrance to the SR 1 southbound on-ramp from the entrance to Pebble Beach, creating two legs on the south side of the intersection. The signal concept was included as the preferred alternative in the approved PR for the Holman Highway Widening Project, and was outlined as a Phase 2 improvement as a mitigation for the Pebble Beach Development Project. The proposed intersection configurations are shown in Figure 5 and 6 below for the 2015 and 2030 traffic conditions, respectively.

The primary difference between the 2015 and 2030 signal configurations is the addition of a second eastbound lane on SR 68, and the addition of channelization on the southbound right-turn lane from the SR 1 southbound off-ramp to SR 68 westbound. In the 2015 configuration, the eastbound right-turn lane would serve traffic bound to both Pebble Beach/17 Mile Drive and the SR 1 southbound on-ramp.

In the 2030 signal configuration, the outside eastbound through lane terminates at the entrance to the SR 1 southbound on-ramp. The signal alternative assumes that the two-lane overcrossing of SR 68 over SR 1 will remain in place.

The signal alternative requires a portion of a two lane entrance ramp to southbound SR 1 made possible by constructing a retaining wall along west edge of the ramp. The two lanes would merge to a single lane entrance ramp near the point of entering SR 1 southbound, as shown in Figure 2. The configuration of the two-lane ramp merging to one at the same point as it merges into the SR 1 southbound mainline is unconventional for two lane entrance ramp configurations and not consistent with Caltrans single or two lane standard details.

**Figure 2 Traffic Signal Alternative – SR 1 Southbound On-Ramp Configuration**

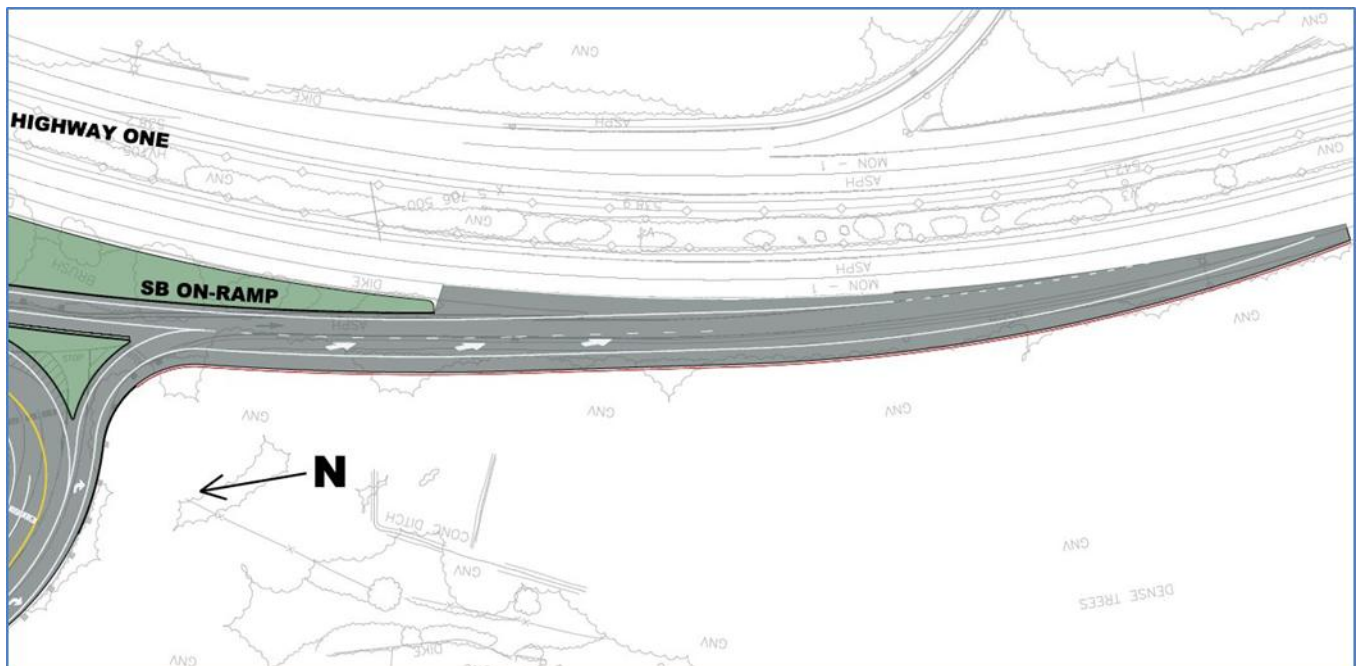

Figure 3 2015 Traffic Scenario Roundabout Configuration

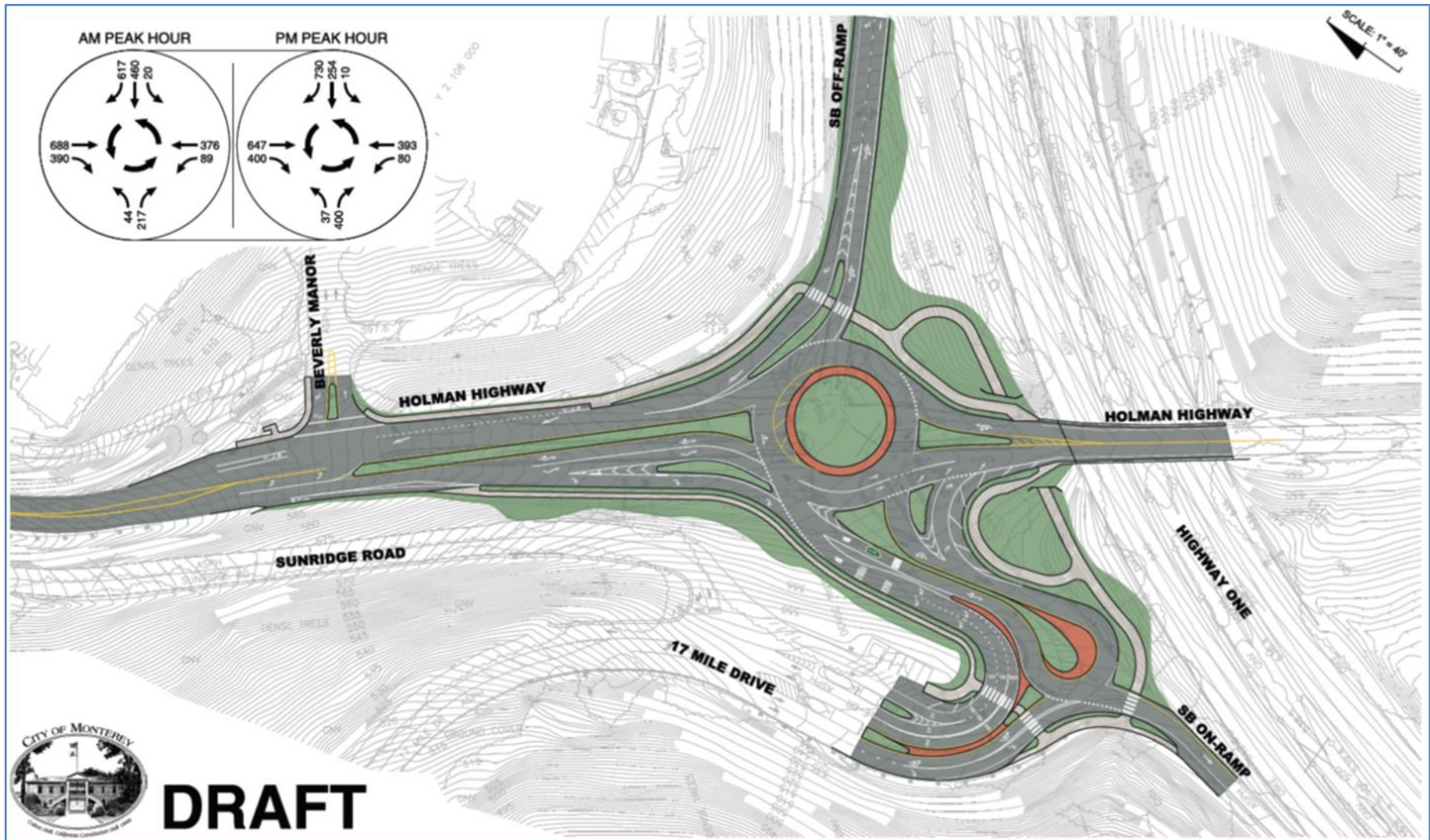



Figure 4 2030 Traffic Scenario Roundabout Configuration

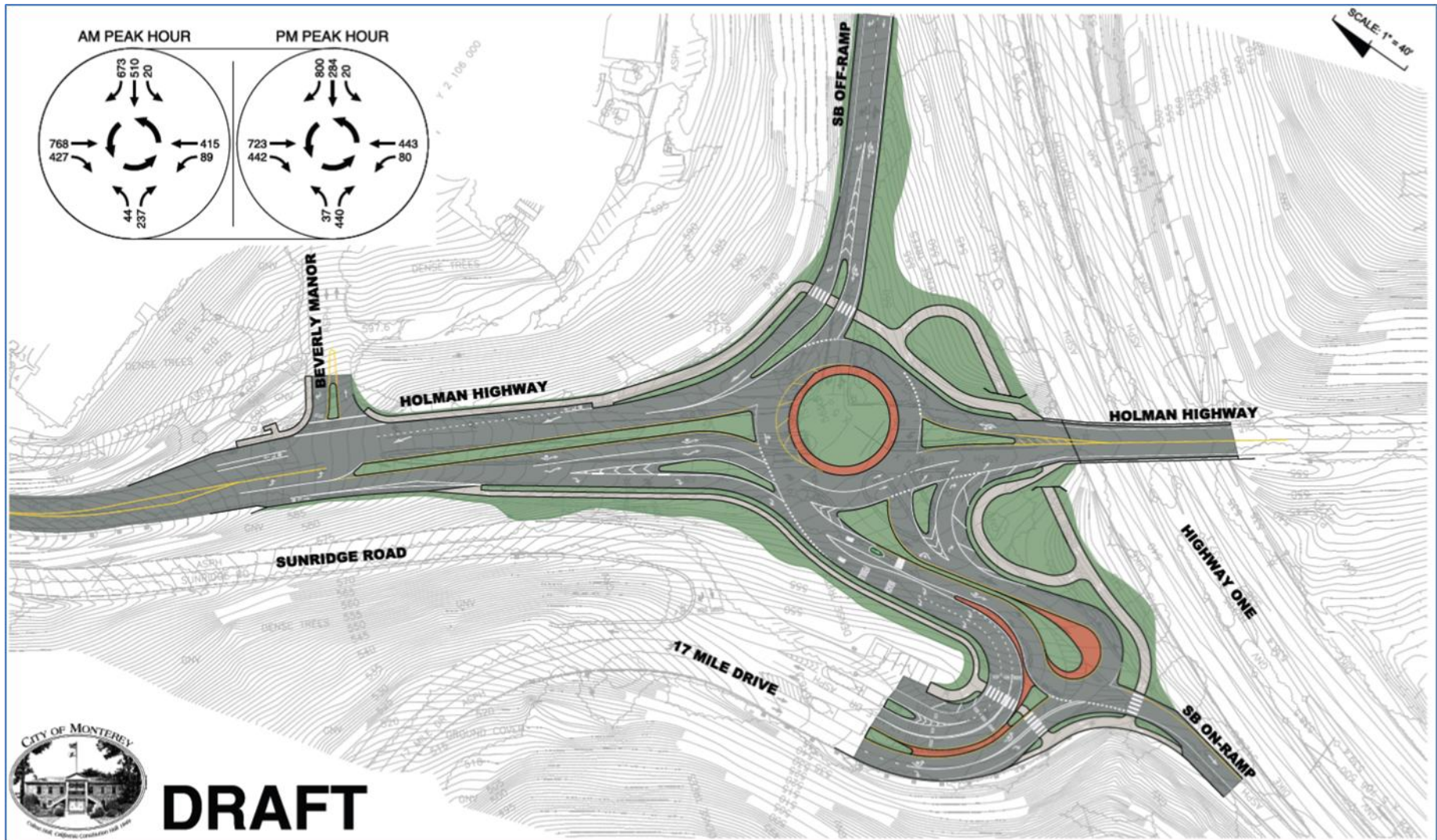



Figure 5 2015 Traffic Scenario Signal Configuration

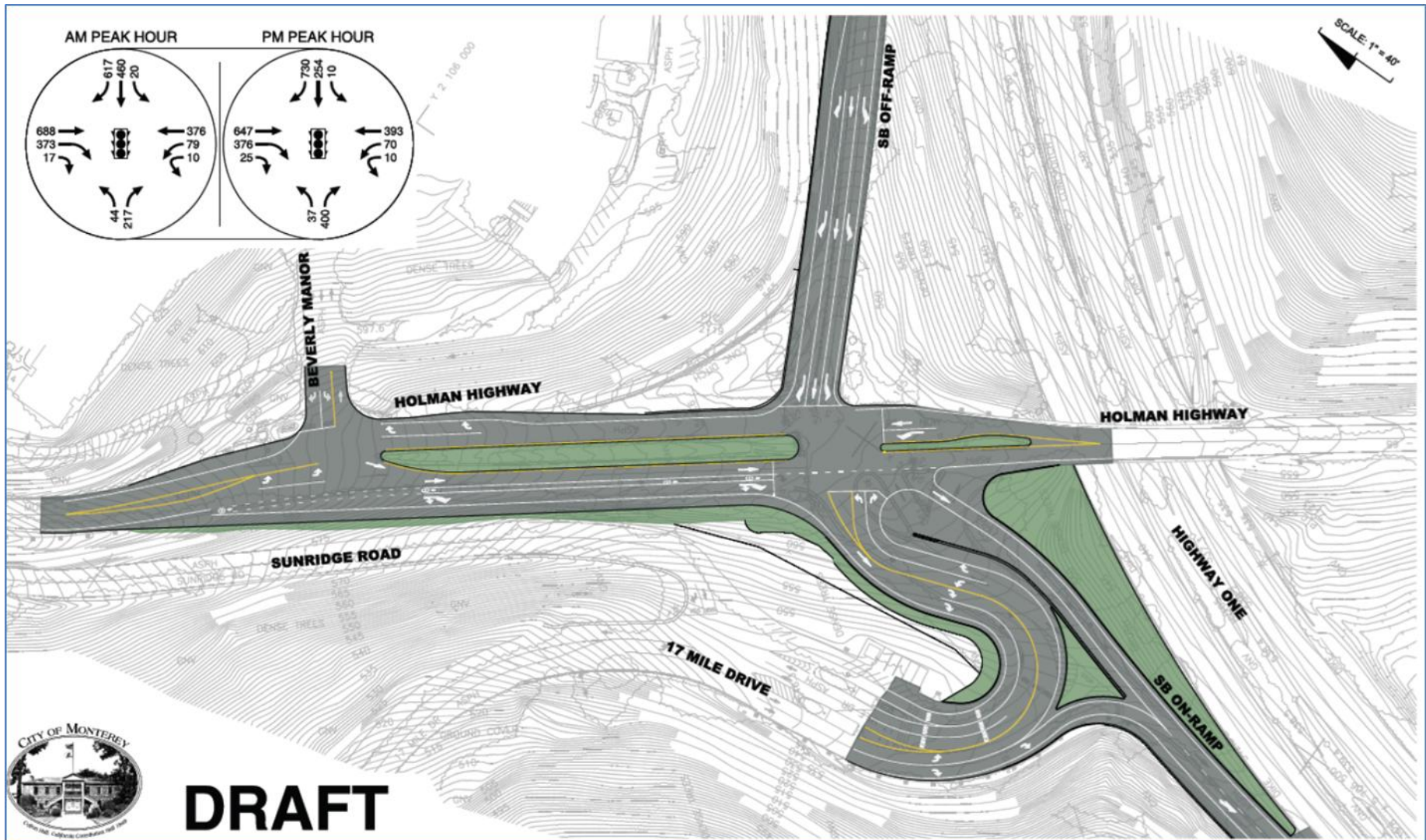
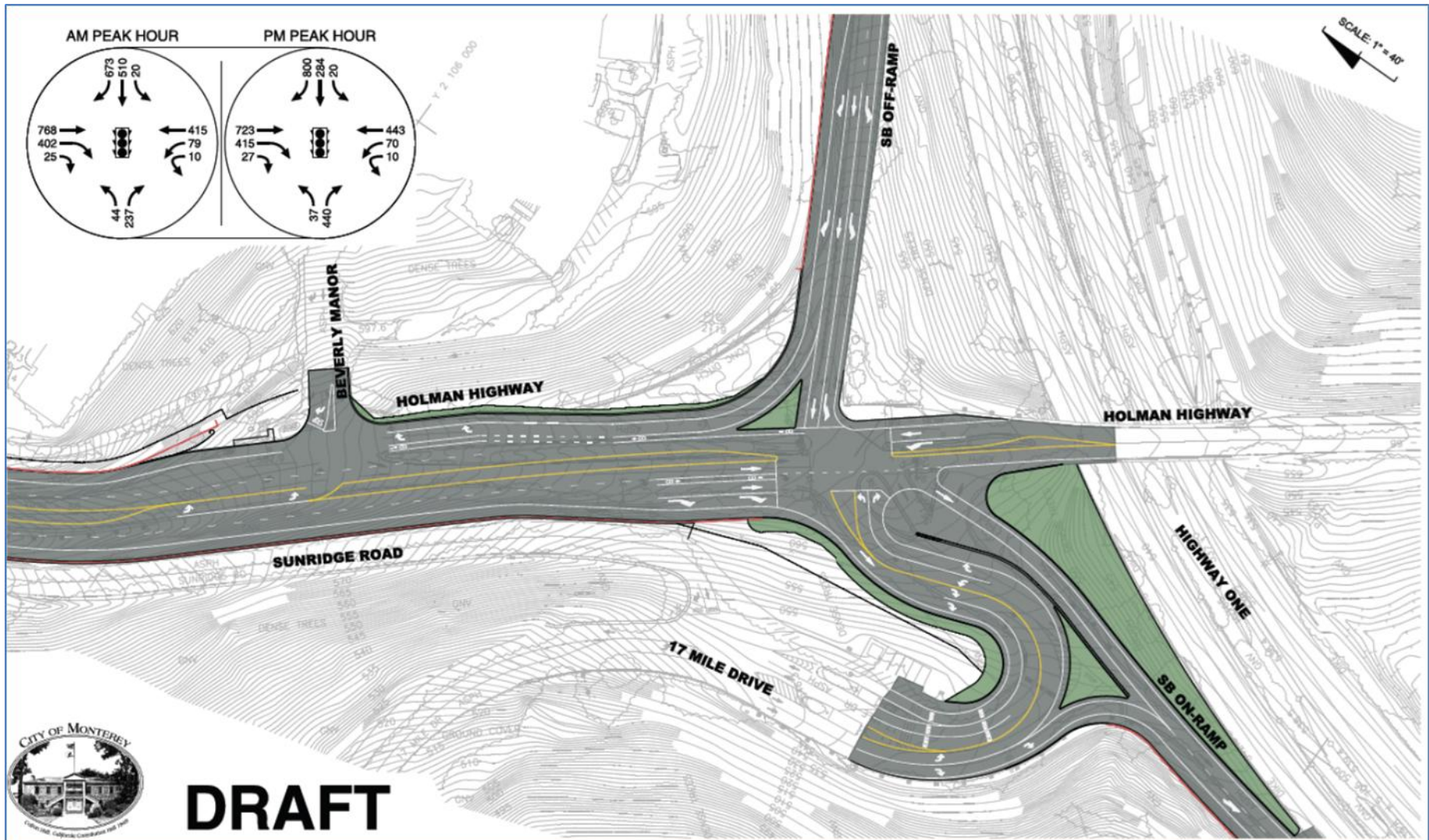

Figure 6 2030 Traffic Scenario Signal Configuration



Section 5  
Operations



## OPERATIONS

The traffic operations of the traffic signal and roundabout alternatives were analyzed for AM and PM peak hours in the 2015 and 2030 traffic scenarios using the traffic volumes presented in Table 1 above. The traffic signal was analyzed using Synchro traffic analysis software, and the roundabout was analyzed using SIDRA analysis software. Analysis procedures from the 2010 *Highway Capacity Manual* (HCM) were used within each software program to determine the level-of-service (LOS), critical volume-to-capacity ratios (V/C), and queuing characteristics of the two alternatives. Caltrans-specific roundabout capacity parameters were used in the analysis of the roundabout alternative. The results of the 2015 analysis are presented in Table 4 and the results of the 2030 analysis are presented in Table 6.

The Synchro analysis outputs for the traffic signal alternative are provided in Attachment D. The SIDRA analysis outputs for the roundabout alternative are provided in Attachment E.

### 2015 OPERATIONS

**Table 4 2015 Traffic Operations Comparison – SR 68 at SR 1 Southbound Ramp Termini**

Approach	Signal				Roundabout			
	Volume to Capacity Ratio	Delay (sec)	Level of Service	95th Percentile Queue (veh)	Volume to Capacity Ratio	Delay (sec)	Level of Service	95th Percentile Queue (veh)
2015 AM								
Eastbound	1.39	160.8	F	>30	0.80	14.4	B	12
Westbound	1.24	62.0	E	11	0.46	5.3	A	3
Northbound	0.62	19.1	B	5	0.33	6.6	A	2
Southbound	1.48	242.8	F	>40	0.71	17.4	C	8
2015 PM								
Eastbound	1.03	56.5	E	>25	0.54	7.5	A	5
Westbound	0.89	30.7	C	10	0.44	5.1	A	3
Northbound	0.62	23.1	C	11	0.52	6.4	A	3
Southbound	1.03	60.5	E	>20	0.50	13.8	B	3

Table 4 shows the traffic signal alternative is expected to operate at LOS F during the AM peak hour, and LOS E during the PM peak hour in the 2015 traffic scenario. Additionally, the eastbound, westbound, and southbound approaches of the intersection will operate with a V/C ratio greater than 1.0 in the 2015 AM peak hour, with the eastbound and southbound approaches operating with a V/C ratio greater than 1.0 in the PM peak hour. Significant queuing is also expected with the traffic signal on the eastbound and southbound approaches, and the westbound left-turn queue is expected to exceed the storage length in both peak periods. The westbound left-turn storage is constrained by the existing width of the two-lane bridge over SR 1.

The southbound queue from the SR 1 off-ramp for the signal alternative in 2015 is expected to extend approximately 1,150 feet; nearly to the painted gore where the off-ramp meets the SR 1 southbound



mainline. Upstream of the painted gore, the southbound off-ramp extends back as an auxiliary lane. The expected length of the southbound queue in 2015 is shown in Figure 7.

**Figure 7 2015 Traffic Signal Alternative – Southbound Off-Ramp Queue**

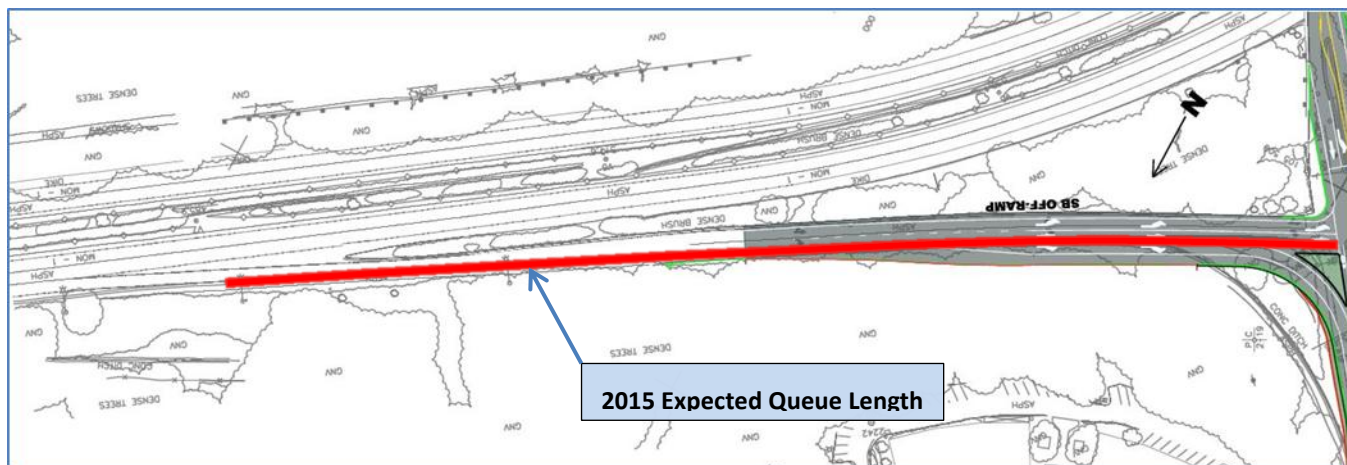

The operation of the traffic signal assumes all vehicles destined to SR 1 southbound will be correctly positioned in the right-turn lane approaching the intersection eastbound. This will require adequate signing to inform drivers that they need to be in that lane, as well as provide guidance to the two destinations (SR 1 southbound and Pebble Beach) reached from that lane. If pre-segregation is not achieved, drivers will need to change lanes in the intersection.

The roundabout alternative is expected to operate at LOS C in the 2015 AM peak hour and LOS B in the 2015 PM peak hour. The roundabout is expected to have adequate capacity with a V/C ratio of 0.80 on the eastbound approach in the AM peak hour and 0.63 in the PM peak hour. Additionally, queuing is anticipated to be shorter with the roundabout alternative than with the signal alternative. Because of the existing two-lane bridge over SR 1, the roundabout alternative assumes that the outside eastbound lane merges just downstream of the roundabout, as shown in Figure 3. This is expected to cause an under-utilization of the outside eastbound through lane, which was accounted for in the roundabout analysis.

The signal and roundabout alternatives were compared based on the performance criteria of 2015 traffic operations. The alternatives were found to meet the performance criteria if they operate at LOS D or better and are not expected to experience significant queue spillback on SR 68 or the SR 1 SB Off-Ramp. Additionally, a V/C threshold of 1.0 was used for the signal alternative and a V/C threshold of 0.85 was used for the roundabout alternative. Table 5 summarizes the performance comparison for 2015 operations. The roundabout was found to better meet the performance criteria for 2015 traffic operations.

**Table 5 Performance Comparison – 2015 Operations**

Performance Measure	Signal	Roundabout
Delay – All approaches LOS “D” or better		✓
Capacity – All signal approaches 1.0 V/C or better, All roundabout approaches 0.85 V/C or better		✓
95 <sup>th</sup> Percentile Queue – Adequate queue storage		
SR 68 (Holman Hwy) queue		✓
SR 1 SB Off-Ramp queue		✓

✓ = Meets performance criteria

## 2030 OPERATIONS

Table 6 shows the traffic signal alternative is expected to operate at LOS D during the AM and PM peak hours in the 2030 traffic scenario. The eastbound, westbound, and southbound approaches of the intersection will operate at or near a V/C ratio of 1.0 in the AM peak hour, and the eastbound and westbound approaches will operate near capacity during the PM peak hour. Queuing on the eastbound and southbound approaches is expected to be reduced from the 2015 signal operations, though queues are forecast to be longer than the roundabout alternative. The westbound left-turn queue is expected to exceed the storage length in both peak periods. The westbound left-turn storage is constrained by the existing width of the two-lane bridge over SR 1.

**Table 6 2030 Traffic Operation Comparison – SR 68 at SR 1 Southbound Ramp Termini**

Approach	Signal				Roundabout			
	Volume to Capacity Ratio	Delay (sec)	Level of Service	95 <sup>th</sup> Percentile Queue (veh)	Volume to Capacity Ratio	Delay (sec)	Level of Service	95 <sup>th</sup> Percentile Queue (veh)
2030 AM								
Eastbound	1.02	47.7	D	>30	0.90	26	D	13
Westbound	0.98	32.7	C	9	0.42	6.7	A	3
Northbound	0.79	32.3	C	7	0.37	9.2	A	2
Southbound	1.02	32.9	C	>20	0.78	10.4	B	8
2030 PM								
Eastbound	0.95	32.7	C	>20	0.63	11.0	B	6
Westbound	0.97	28.0	C	8	0.42	6.6	A	3
Northbound	0.86	40.4	D	16	0.63	14.8	B	5
Southbound	0.61	9.2	A	9	0.55	3.0	A	3

The improvement to the operations of the traffic signal alternative can be attributed to an additional lane eastbound on SR 68, as well as the channelization of the southbound right-turn lane to allow for free-flow right-turn movements from the SR 1 off-ramp. However, the operations assume all eastbound vehicles destined to the SR 1 southbound on-ramp will be correctly positioned in the outside through lane which drops in the intersection, and all eastbound through vehicles positioned in the inside through lane. This will require adequate advance signing eastbound to inform drivers traveling through

the intersection that they need to be in the inside through lane to avoid merging left within the intersection.

The roundabout concept analyzed for 2030 is identical to that analyzed for 2015. The roundabout alternative is expected to operate at LOS D in the 2030 AM peak hour and LOS B in the 2030 PM peak hour. The roundabout is expected to operate with a V/C ratio of 0.90 on the eastbound approach in the 2030 PM peak hour. All other approaches are expected to operate with a V/C ratio of 0.78 or better. Additionally, queuing is anticipated to be shorter with the roundabout alternative than with the signal alternative. Similar to the 2015 analysis, the roundabout alternative assumes the outside eastbound lane merges just downstream of the roundabout because of the existing two-lane bridge over SR 1. This is expected to cause an under-utilization of the outside eastbound through lane, which was accounted for in the roundabout analysis.

The signal and roundabout alternatives were compared based on the performance criteria of 2030 traffic operations. The alternatives were found to meet the performance criteria if they operate at LOS D or better and are not expected to experience significant queue spillback on SR 68 or the SR 1 southbound off-ramp. Additionally, a V/C threshold of 1.0 was used for the signal alternative and a V/C threshold of 0.85 was used for the roundabout alternative. Table 7 summarizes the performance comparison for 2030 operations. Neither alternative meets the capacity threshold criteria for 2030 operations; however the roundabout was found to better meet the performance criteria overall.

**Table 7 Performance Comparison – 2030 Operations**

Performance Measure	Signal	Roundabout
Delay – All approaches LOS “D” or better	✓	✓
Capacity – All signal approaches 1.0 V/C or better, All roundabout approaches 0.85 V/C or better		✓ *
95 <sup>th</sup> Percentile Queue – Adequate queue storage		
SR 68 (Holman Hwy) queue		✓
SR 1 SB Off-Ramp queue	✓	✓

✓ = Meets performance criteria

\* = Does not meet threshold. Represents best performance of the two alternatives.

## FUTURE INVESTMENT NEEDED TO EXTEND SERVICE LIFE

### *Traffic Signal Alternative*

The traffic signal alternative as shown in Figure 5 can be built in the interim (2015) by reconfiguring the SR 1 southbound on-ramp and Pebble Beach gate access, adding turn lanes on the SR 1 southbound off-ramp, and adding the second eastbound approach lane. The improvements to the west leg of the intersection would be built at the ultimate footprint required for the 2030 configuration, which includes retaining walls and the possible realignment of Sunridge Road along the south side of SR 68. This configuration is expected to operate over capacity and with high delay and queues from the beginning, so effective operations service life does not apply.

To provide additional operating capacity to accommodate 2030 traffic conditions, the signal alternative requires widening SR 68 to four lanes to the west and the channelization of the southbound right-turn lane from the SR 1 southbound off-ramp to operate as a free-flow lane. This configuration would improve traffic operations to LOS D and reduce the V/C ratios on most approaches to less than 1.0.

### **Roundabout Alternative**

The traffic operations analysis presented above indicates the roundabout intersection alternative requires no additional improvements from those proposed for the 2015 Interim design year to extend the design life to 2030. The eastbound approach leg of the roundabout would operate with a V/C of 0.90 in 2030, which is higher than the practical V/C limit of 0.85. Improvements that would further extend the operating design life of the roundabout alternative are adding a second southbound through lane from the SR 1 southbound off-ramp, or widening the SR 68 overcrossing of SR 1 to three lanes (one additional eastbound lane). Either of the improvements would distribute traffic more evenly through the roundabout and allow for improved operations on the eastbound intersection approach.

The 2015 interim roundabout configuration can be constructed as to not preclude the future widening of SR 68 to three lanes. The west leg of the intersection on SR 68 would be built at the proposed alignment and footprint of the future 3-lane widening. The roundabout configuration would also accommodate future widening of the SR 68 bridge over SR 1 if carried forward with the Holman Highway Widening Project. Widening the bridge would improve the operations of the eastbound roundabout approach by extending the downstream merge and evenly distributing traffic between the two through lanes.

The signal and roundabout alternatives were compared based on the performance criteria of the future investment needed to extend the service life of the intersection. The basis for the performance of the alternatives was a comparison of which alternative requires the least investment to extend the service life. The roundabout alternative was found to best meet the performance criteria, as shown in Table 8.

**Table 8 Performance Comparison – Future Investment Needs**

Performance Measure	Signal	Roundabout
Least Future Investment Needed to Extend Design Life		✓

## LIFE-CYCLE COST

A concept-level comparison of life-cycle cost components was performed for the traffic signal and roundabout alternatives. More detailed construction cost estimates for the alternatives were not performed as part of the ICE in order to compare the initial capital costs. A 20-year life-cycle was assumed for the evaluation. The 2015 interim and 2030 ultimate configurations for each of the alternatives are not expected to differ significantly, so the comparison below is based on the 2015 interim configuration. The following life-cycle cost components are discussed below for comparison purposes:

- Operations and maintenance (traffic signal only)
- Landscaping maintenance
- Pavement Rehabilitation
- Crash costs

## Operations & Maintenance

The traffic signal alternative is expected to require an annual operations and maintenance budget over the 20-year life cycle. The operations and maintenance is expected to cost approximately \$6,000 per year, totaling \$120,000 over the 20-year life cycle.

The roundabout alternative is not expected to require similar operations and maintenance costs over the design life.

## Landscaping Maintenance

Both alternatives require the establishment of landscaping in areas affected by the construction of the alternative, as well as median and island areas integral to the alternatives. These areas will also require maintenance of the landscaped areas over the life cycle. The estimated landscaped areas are shown in green in the alternative concepts in Figure 3 through Figure 6. The 2015 interim traffic signal alternative has approximately 3,900 square yards (0.8 acres) of landscaped area, while the roundabout alternative has approximately 6,200 square yards (1.27 acres) of landscaped area. Based on the concept-level estimates, the roundabout alternative will have approximately 60% higher landscape maintenance costs than the traffic signal alternative.

## Pavement Rehabilitation

Both alternatives are expected to require an asphalt pavement overlay within the 20-year life cycle to maintain the pavement condition. The total pavement areas of the 2015 interim alternative concepts were compared to determine the relative life cycle costs associated with pavement rehabilitation. The area considered included the total area impacted by the proposed concepts, and extends to where the alternative concept transitions back to the existing cross-section. In general, these impacts consist of widening on the SR 1 ramps and widening to the west on SR 68. The 2015 interim traffic signal alternative has approximately 17,950 square yards (3.7 acres) of pavement area, while the roundabout has approximately 13,350 square yards (2.75 acres) of pavement area. Based on the concept-level estimates, the traffic signal alternative will have approximately 35% higher pavement rehabilitation costs than the roundabout alternative.

## Crash Costs

Costs associated with vehicle collisions have not been quantified, but a comparison based on expected crash reductions for the intersection type is provided. The “Safety Characteristics” section below provides more detail on the expected safety performance of the alternatives. The *Highway Safety Manual* (HSM) contains a Crash Modification Factor (CMF) for converting a traffic signal to a roundabout. The CMF predicts a 24% reduction in total crashes and a 66% reduction in fatal/severe injury crashes with the conversion of a traffic signal to a roundabout. A summary of 2010 average comprehensive costs for various crash severities from the National Safety Council are provided below for reference.

- Fatality \$4,360,000
- Class A incapacitating injury \$ 220,300
- Class B evident injury \$ 56,200
- Class C possible injury \$ 26,700
- Property damage only \$ 2,400

The roundabout alternative is expected to have lower life cycle costs associated with motor vehicle crashes based on the expected crash performance compared to the traffic signal alternative.

## Life Cycle Cost Summary

The signal and roundabout alternatives were compared based on the life cycle costs expected for each alternative. The alternative with the lower expected costs over the 20-year life cycle was considered to best meet the performance criteria. Table 9 summarizes the comparison for the life cycle cost components.

**Table 9 Performance Comparison – Life Cycle Costs**

Performance Measure	Signal	Roundabout
Operations & Maintenance – Lowest Cost		✓
Landscaping Maintenance – Lowest Cost	✓	
Pavement Rehabilitation – Lowest Cost		✓
Crash Costs – Lowest Cost		✓

Section 6  
Geometrics and Other Design Considerations

## GEOMETRICS AND OTHER DESIGN CONSIDERATIONS

### GUIDE SIGNING

Due to the unconventional forms of the signal and roundabout alternatives being evaluated, guide signing could have an impact on traffic operations. The key aspects of guide signing for the signal alternative are as follows:

- Eastbound direction:
  - Guidance to the multiple destinations and multiple decision points (Pebble Beach, SR 1 NB, SR 1 SB)
  - Segregating through traffic to the inside lane only
  - Delineating the two destinations (SR 1 southbound and Pebble Beach) that are physically separated but both accessed from the outside lane.
- Southbound direction:
  - Guidance to SR 1 southbound and Pebble Beach
- Westbound direction:
  - Delineating the two destinations (Pebble Beach and SR 1 southbound) that are physically separated by both accessed from the left-turn lane.

The key aspects of the guide signing for the roundabout alternative are as follows:

- Eastbound direction:
  - Provide adequate advance guidance on the multiple destinations (Pebble Beach, SR 1 northbound, SR 1 southbound)
  - Provide guidance at the entry point of the right turn lane. Decision point to either Pebble Beach or SR 1 southbound.

Other key aspects of the roundabout guide signing would be to convert the existing guide signing messages to be specific to the change in movements typical with a roundabout (i.e. circulating to make a left-turn). Both the roundabout and traffic signal require clear messaging to direct traffic to the destinations, but the signal requires additional messaging related to the added decision points and specific lane designation for traffic in the eastbound direction. For the 2030 ultimate configuration, the signal may require overhead lane-use signing in the eastbound direction to direct through traffic into the inside lane, and traffic destined to SR 1 southbound is in the outside lane.

Guide signing concepts for the 2015 interim configurations of both alternatives were prepared and included in Attachment F.



The signal and roundabout alternatives were compared based on the complexity of the guide signing needed to support the geometric configuration proposed. The signal alternative requires more guidance to direct drivers to the correct destinations, as well as to designate traffic into specific lanes compared to the roundabout. The roundabout alternative was found to best meet the performance criteria for complexity of signing, as shown in Table 10.

**Table 10 Performance Comparison – Guide Signing**

Performance Measure	Signal	Roundabout
Guide Signing Complexity		✓

## TRUCK ACCOMMODATION

The design vehicle for the intersection of SR 68 with the SR 1 Ramp Termini is the STAA-Standard truck. Vehicle turning templates using the STAA-Standard truck were run for key movements of the 2015 interim alternative concepts to test if they accommodate the required vehicles. The key vehicle movements evaluated are described below. Exhibits showing each of the design vehicle checks are provided in Attachment G.

### *Northbound Right-Turn from Pebble Beach*

- Roundabout alternative: The design vehicle uses both lanes exiting Pebble Beach.
- Signal alternative: The design vehicle uses both lanes exiting Pebble Beach. The design vehicle also encroaches on the northbound left-turn lane at the SR 68 intersection.

### *Hwy 1 Southbound Off-Ramp to Southbound On-Ramp*

- Signal alternative: Unconventional movement for oversize loads.
- Roundabout alternative: Conventional movement. Decision point exiting roundabout to Pebble Beach or SR 1 southbound.

### *WB Left-Turn to Pebble Beach*

- Signal alternative: Requires the full pavement width entering Pebble Beach. Slight encroachment into oncoming lanes entering Pebble Beach.
- Roundabout alternative: Requires the full pavement width entering Pebble Beach.

### *WB Left-Turn to Hwy 1 SB Ramp*

- Signal alternative: STAA-Standard design vehicle not accommodated. The largest vehicle accommodated is a “Motorhome” design vehicle that must start the left-turn movement from the westbound through lane.

- Roundabout alternative: Conventional movement. Decision point exiting roundabout to Pebble Beach or SR 1 southbound.

The signal and roundabout alternatives were compared based on the ability to adequately serve the required design vehicle for all movements. As outlined above, the traffic signal alternative does not adequately serve the design truck for the westbound left-turn to the SR 1 southbound on-ramp. The roundabout alternative serves the design truck for all movements. Table 11 summarizes the finding the roundabout alternative best fits the performance criteria for accommodating trucks.

**Table 11 Performance Comparison – Truck Accommodation**

Performance Measure	Signal	Roundabout
Serves design vehicle for all movements		✓

## SAFETY CHARACTERISTICS

The *Highway Safety Manual* (HSM) provides a relative comparison of the safety characteristics of the two alternatives. The HSM provides Crash Modification Factors (CMFs) for various conditions that help to quantify the relative change in predicted crashes due to the change in condition.

### Predictive Measures

The HSM contains a CMF for converting a traffic signal to a roundabout. The base condition is the presence of a traffic signal, and the CMF predicts a 24% reduction in total crashes (standard error +/- 10%) and a 66% reduction in fatal/severe injury crashes (standard error +/- 12%) with the conversion of the base condition to a roundabout. The CMF does not account for the closely spaced downstream intersection which introduces additional decision points and conflicts. However, the safety performance trends for the roundabout appear to generally be preserved with the proposed concept. The traffic signal concept includes qualities and features that deviate from contemporary design principles, which may skew the amount of relative change in predicted crashes with the signal versus the roundabout.

### Surrogate Safety Measures

Since a detailed safety study was not conducted for this ICE, several measures that are commonly looked at as surrogates for anticipating the likelihood or severity of a crash on a given facility were used to evaluate the two alternatives. These surrogates are summarized as follows:

- Number of Conflict Points
  - 23 for 2015 Interim signal concept
  - 20 for 2015 Interim roundabout concept
  - Signal - Queue spillback from signal westbound to southbound
- Reduced Speed Potential

- Roundabout reduces speeds in the intersection
- Roundabout reduces speed differential on southbound entrance ramp
- Crash Severity Potential
  - Roundabout eliminates most severe crash types

The signal and roundabout alternatives were compared based on the anticipated safety performance. The two performance measures used were the predictive measures and the surrogate safety measures. The roundabout was found to have a predicted reduction in total and fatal/injury crashes compared to the signal alternative, as documented in the HSM CMFs. The roundabout alternative was also found to have characteristics that are commonly used as surrogates for having a reduced likelihood for the number and severity of crashes. Table 12 summarizes the safety performance comparison between the traffic signal and roundabout alternatives.

**Table 12 Performance Comparison – Safety Characteristics**

Performance Measure	Signal	Roundabout
Predictive Measures – Greatest crash reduction potential		✓
Safety Surrogates – Best anticipated safety performance		✓

## BICYCLE AND PEDESTRIAN ACCOMMODATION

The accommodation of bicycles and pedestrians through the study intersection was compared for the two alternatives.

### *Traffic Signal Alternative*

The traffic signal alternative accommodates bicycles much in the same way as they are accommodated in the existing condition. In the interim concept, bicycles are provided a marked lane in the eastbound direction between the through lane and the right-turn lane. In the ultimate configuration, bicycles are provided a marked lane westbound through the intersection, which transitions to a paved shoulder to the west. The channelized southbound right-turn lane in the ultimate signal configuration creates a weaving maneuver with bicycles traveling through the intersection, as well as with vehicles turning right into Beverley Manor.

No improvements to pedestrian facilities are proposed with the approved traffic signal concept. Signalized pedestrian crossings could be added to the west and north legs of the intersection to provide connections across and along SR 68 and to Pebble Beach.

### *Roundabout Alternative*

Bicycles can be accommodated through the SR 68/SR 1 Ramp Termini intersection in two ways with the proposed roundabout alternative. More experienced bicyclists may choose to take the lane and travel through the roundabout as a vehicle. For those not wishing to do so, separated bike and pedestrian

facilities can be added adjacent to the intersection to allow bicyclists to leave the roadway and navigate around the roundabout as a pedestrian. No additional bike facilities are proposed on the approach legs to the roundabout alternative. The concepts in Figures 3 and 4 show potential accommodations for bicycles.

The roundabout alternative also shows potential pedestrian improvements that can be added with the project to improve pedestrian access across and along SR 68. At-grade and grade-separated pedestrian and bike crossings are shown in the concept plans for providing access between the north and south sides of SR 68, as well as additional sidewalk along the north side of SR 68 that extends west to Beverley Manor.

The performance of the signal and roundabout alternatives were compared based on the ability to accommodate pedestrians and bicycles through the intersection and study area. In general, both alternatives have the ability to accommodate pedestrians and bicycles; however, the signal alternative concept as approved does not provide the same level of pedestrian access through the study area compared to the roundabout concept. Table 13 summarizes the performance comparison of the traffic signal and roundabout alternatives with regard to accommodating pedestrians and bicycles.

**Table 13 Performance Comparison – Pedestrian and Bicycle Accommodations**

Performance Measure	Signal	Roundabout
Pedestrian Accommodation		✓
Bicycle Accommodation		
2015 Interim Configuration	✓	✓
2030 Ultimate Configuration		✓

Section 7  
Non-Conforming Features

## NON-CONFORMING FEATURES

### APPROVED DESIGN EXCEPTIONS

Four non-standard mandatory design features and one advisory design feature were approved in December 2000 as part of the PSR Process for the Holman Highway Widening Project. Mike Janzen, HQ Design Reviewer, on January 12, 2006 reviewed two design exception fact sheets approved November 8, 2000 and November 22, 2000 and concurred that they continue to be appropriate for current use.

The mandatory design exceptions associated with the proposed four-lane widening and signalized intersection alternative include:

1. Horizontal Curve Radii: Curve 2 is an existing curve with a radius of 167.64 meters (550 feet). This radius will be maintained. Curve 3 is a new curve with radius of 167.64 meters (550 feet), which replaces an existing curve with radius 144 meters (472 feet).
2. Superelevation: Curve 1 will maintain the existing superelevation rate of 0.04 and 496 meter (1627 feet) radius curvature to conform to the existing roadway at the westerly project limits. Curve 2 will maintain existing curvature with a radius of 168 meters (550 feet) and will have a superelevation of 0.09.
3. Ramp/Local Road Intersection Spacing: The intersection of SR 68, the southbound ramps and the Pebble Beach Entrance will become a five-leg intersection with non-standard distance between the southbound on-ramp and Pebble Beach Entrance. Additionally, Pebble Beach Entrance intersects the southbound on-ramp with a right-turn only lane. The new configuration improves the two-way traffic condition that exists between SR 68 and the southbound on-ramp.
4. Access Control: Existing access control line will be changed. The new configuration of the intersection provides for access control between Pebble Beach Entrance and the southbound on-ramp as shown.

One non-standard advisory design feature was approved November 2000 which was the inability for California trucks to make the left-turn movement from westbound SR 68 to the southbound SR 1 on-ramp. California trucks and buses will have to continue toward Pacific Grove to seek a return route to SR 1. Appropriate mitigation and signing will be included.

### DEVIATIONS FROM HDM DESIGN STANDARDS

The following deviations from the California *Highway Design Manual* (HDM) have been identified and may require design exception fact sheet approval.

---

### **Traffic Signal Alternative**

Using Chapter 400 (Intersections At Grade) of the Caltrans *Highway Design Manual* (HDM) the following potential deviations of the alternative concepts from the design standards were identified:

- Items number 3 and 4 of the “Approved Design Exceptions” section above apply to the signalized intersection alternative.
- The proposed signal concept maintains the westbound left-turn restriction to California trucks and buses.
- The signalized intersection alternative deviates from design standards with inadequate proposed westbound left-turn storage because of the constraint of the existing bridge.

### **Roundabout Alternative**

The roundabout alternative is expected to deviate from HDM design standards similar to the traffic signal alternative only for Item 3 and 4 of the “Approved Design Exceptions” section above. The roundabout configuration may require the same intersection spacing and access control design exceptions that have been approved for the signal concept. No other deviations from HDM design standards are expected for the roundabout alternative.

## **NONCONFORMING ROUNDABOUT FEATURES**

The roundabout alternative concept was compared to the National Cooperative Highway Research Program (NCHRP) Report 672 *Roundabouts: An Informational Guide* to determine any non-conforming features. The preliminary roundabout concept presented in this ICE was found to conform to the guidance contained in *Roundabouts: An Informational Guide*.

## Section 8 Recommendations



## RECOMMENDATIONS

The analysis provided above for this ICE presented an objective comparison between the two intersection control alternatives for the SR 68/SR 1 Southbound Ramp Termini intersection and adjacent intersection at the Pebble Beach Gate/SR 1 Southbound On-Ramp. Based on the analysis of the alternatives for several key performance criteria, the results of the ICE are summarized in Table 14.

**Table 14 Alternatives Performance Comparison**

Performance Measure	Signal	Roundabout
<b>2015 Operations</b>		
Delay – All approaches LOS “D” or better		✓
Capacity – All signal approaches 1.0 V/C or better, All roundabout approaches 0.85 V/C or better		✓
95 <sup>th</sup> Percentile Queue – Adequate queue storage		
SR 68 (Holman Hwy) queue		✓
SR 1 SB Off-Ramp queue		✓
<b>2030 Operations</b>		
Delay – All approaches LOS “D” or better	✓	✓
Capacity – All signal approaches 1.0 V/C or better, All roundabout approaches 0.85 V/C or better		✓ *
95 <sup>th</sup> Percentile Queue – Adequate queue storage		
SR 68 (Holman Hwy) queue		✓
SR 1 SB Off-Ramp queue	✓	✓
<b>Future Investment Needs</b>		
Least Future Investment Needed to Extend Design Life		✓
<b>Life Cycle Costs</b>		
Operations & Maintenance – Lowest Cost		✓
Landscaping Maintenance – Lowest Cost	✓	
Pavement Rehabilitation – Lowest Cost		✓
Crash Costs – Lowest Cost		✓
<b>Guide Signing</b>		
Guide Signing Complexity		✓
<b>Truck Accommodation</b>		
Serves design vehicle for all movements		✓
<b>Safety Characteristics</b>		
Predictive Measures – Greatest crash reduction potential		✓
Safety Surrogates – Best anticipated safety performance		✓
<b>Pedestrian and Bicycle Accommodation</b>		
Pedestrian Accommodation		✓
Bicycle Accommodation		
2015 Interim Configuration	✓	✓
2030 Ultimate Configuration		✓
<b>Total Performance Measures Met</b>	<b>4</b>	<b>19</b>

The roundabout intersection alternative was found to perform better than the traffic signal alternative in almost all criteria. The operations of the traffic signal were found to not be acceptable in the 2015 or 2030 design years, and the 4-lane widening of SR 68 is required to accommodate the proposed ultimate 2030 traffic signal configuration. The roundabout alternative can be constructed independently of the future 4-lane widening of SR 68.

The geometric and design considerations considered in this study favored the roundabout alternative. The roundabout was found to accommodate all traffic movements for the design vehicle, where the traffic signal limits some movements for trucks. The roundabout alternative allows for less complex guide signing through the intersection, where the traffic signal requires specific lane designations to reach destinations in the eastbound and southbound directions. Additionally, the roundabout alternative has better expected safety performance than the traffic signal alternative.

Based on the results, the City of Monterey recommends the roundabout alternative be moved forward as the preferred alternative for the SR 68/SR 1 Southbound Ramp Termini intersection.

As the roundabout alternative is moved forward into PS&E, the City of Monterey will look for opportunities to coordinate with Caltrans and other agencies to refine the proposed concepts.

Attachment A  
Traffic Volumes

Holman Hwy / Highway 1 SB Ramp Intersection  
Roundabout Feasibility Study

ORIGIN - DESTINATION VOLUME WORKSHEET

Volume Set 1: Existing  
Volume Set 2: Existing + Alt 1

Intersection	Approach / Origin	Movement	Existing			Existing + Alt 1			% Difference			Destination	OD Movement	O-D Movement Existing			O-D Movement Existing + Alt 1			% Difference			Notes	
			AM	PM	SAT	AM	PM	SAT	AM	PM	SAT			AM	PM	SAT	AM	PM	SAT	AM	PM	SAT		
Holman Hwy	NB Pebble Beach	LT	32	26		36	33		13%	27%		WB Holman Hwy	LT	32	26		36	33		13%	27%			
		RT	183	358		210	388		15%	8%		EB Holman Hwy	RT	183	358		210	388		15%	8%			
	WB Holman Hwy	T	357	377		363	380		2%	1%		WB Holman Hwy	T	357	377		363	380		2%	1%			
		LT	69	59		78	69		13%	17%		SB On Ramp	LTT / URT	7	7		7	7		0%	0%			1
	SB Off Ramp	LT	12	9		12	9		0%	0%		EB Holman Hwy	LT	12	9		12	9		0%	0%			
		T	418	214		448	248		7%	16%		SB Pebble Beach	T / TRT	418	214		448	248		7%	16%			
		RT	575	694		592	704		3%	1%		SB On Ramp	T	0	0		0	0					2	
	EB Holman Hwy	T	663	611		1023	993		2%	3%		WB Holman Hwy	RT	575	694		592	704		3%	1%			
		RT										EB Holman Hwy	T	663	611		671	628		1%	3%			3
													SB Onramp	RTT / TRT	294	314		352	365		20%	16%		
											SB Pebble Beach	RTRT	70	63		22	23		-69%	-63%			4	

TOTAL INTERSECTION: 2673 2725 2784 2847 4% 4%

TOTAL INTERSECTION: 2673 2725 2784 2847 4% 4%

Intersection	Approach / Origin	Movement	Existing			Existing + Alt 1			% Difference			Destination	OD Movement	O-D Movement Existing			O-D Movement Existing + Alt 1			% Difference			Notes	
			AM	PM	SAT	AM	PM	SAT	AM	PM	SAT			AM	PM	SAT	AM	PM	SAT	AM	PM	SAT		
Pebble Beach	SB Pebble Beach / On Ramp	T	356	366		359	372		1%	2%		SB On Ramp	T	356	366		359	372		1%	2%			
		RT	495	284		541	333		9%	17%		WB Pebble Beach	RT	495	284		541	333		9%	17%			
	EB Pebble Beach	LT	215	384		246	421		14%	10%		WB Holman Hwy	LTLT	32	26		36	33		13%	27%			
		RT	38	73		46	132		21%	81%		EB Holman Hwy	LTRT	183	358		210	388		15%	8%			
											SB On Ramp	RT	38	73		46	132		21%	81%			5	

TOTAL INTERSECTION: 1104 1107 0 1192 1258 0 8% 14%

TOTAL INTERSECTION: 1104 1107 1192 1258 8% 14%

SB On Ramp Volume:	AM	PM
	405	504

Set 1 EB Holman OD Calc

	AM	PM
RT to PB at Int 14:	495	284
From WB Holman Hwy:	7	7
From SB Off-ramp:	418	214
EB T Volume at Int 13:	70	63

Set 2 EB Holman OD Calc

	AM	PM
EB Volume at Int 15:	893	1025
From SB Off:	12	9
From PB:	210	388
EB T Volume at Int 13:	671	628
EB RT Volume at Int 13:	374	388

Notes:

- Assumes only cars to PB Gate are Added to Alt 1
- Assumes no cars exit and re-enter Hwy 1
- Based on Int 15 - See Set 2 EB Holman OD Calc
- Based on Int 14 RT - See Set 1 EB Holman OD Calc
- Set 2 volume based on SB On Ramp Volume from Merge/Diverge worksheets

LEGEND:

xxx	Input Value
xxx	Calculated/Linked Value
xxx	Assumed Value



Volume Set 1: Cumulative 2030 w/o POM		<b>WITHOUT POM TRAFFIC</b>																				O-D Movement			O-D Movement				
Volume Set 2: Cumulative 2030 + Alt 1 w/o POM		Cumulative 2030 w/o POM									Cumulative 2030 + Alt 1									Cumulative 2030 w/o POM			Cumulative 2030 + Alt 1			% Difference			Notes
Intersection	Approach / Origin	Movement	POM			w/o POM			% Difference			Destination	OD Movement	POM			w/o POM			% Difference									
			AM	PM	SAT	AM	PM	SAT	AM	PM	SAT			AM	PM	SAT	AM	PM	SAT	AM	PM	SAT							
Holman Hwy	NB Pebble Beach	LT	40	30		44	37		10%	23%		WB Holman Hwy	LT	40	30		44	37		10%	23%								
		RT	210	410		237	440		13%	7%		EB Holman Hwy	RT	210	410		237	440		13%	7%								
	WB Holman Hwy	T	409	440		415	443		1%	1%		WB Holman Hwy	T	409	440		415	443		1%	1%								
		LT	80	70		89	80		11%	14%		SB On Ramp	LTT / URT	10	10		10	10		0%	0%		1						
	SB Off Ramp	LT	20	20		20	20		0%	0%		SB Pebble Beach	LTRT / LT	70	60		79	70		13%	17%								
		T	480	250		510	284		6%	14%		EB Holman Hwy	LT	20	20		20	20		0%	0%								
		RT	656	790		673	800		3%	1%		SB Pebble Beach	T / TRT	480	250		510	284		6%	14%								
	EB Holman Hwy	T	759	706		1170	1138					SB On Ramp	T	0	0		0	0					2						
		RT	420	429		27	25		2%	2%		WB Holman Hwy	RT	656	790		673	800		3%	1%								
												EB Holman Hwy	T	759	706		768	723		1%	2%		3						
											SB Onramp	RTT / TRT	340	359		402	415		18%	16%		3							
											SB Pebble Beach	RTRT	80	70		27	25		-66%	-64%		4							
TOTAL INTERSECTION:			3074	3145		3185	3267		4%	4%		TOTAL INTERSECTION:			3074	3145		3185	3267		4%	4%							

Volume Set 1: Cumulative 2030 w/o POM		<b>WITHOUT POM TRAFFIC</b>																				O-D Movement			O-D Movement				
Volume Set 2: Cumulative 2030 + Alt 1 w/o POM		Cumulative 2030 w/o POM									Cumulative 2030 + Alt 1									Cumulative 2030 w/o POM			Cumulative 2030 + Alt 1			% Difference			Notes
Intersection	Approach / Origin	Movement	POM			w/o POM			% Difference			Destination	OD Movement	POM			w/o POM			% Difference									
			AM	PM	SAT	AM	PM	SAT	AM	PM	SAT			AM	PM	SAT	AM	PM	SAT	AM	PM	SAT							
Pebble Beach	SB Pebble Beach / On Ramp	T	410	419		412	425		0%	1%		SB On Ramp	T	410	419		412	425		0%	1%								
		RT	570	330		616	379		8%	15%		WB Pebble Beach	RT	570	330		616	379		8%	15%								
	EB Pebble Beach	LT	250	440		281	477		12%	8%		WB Holman Hwy	LTLT	40	30		44	37		10%	23%								
		RT	50	90		59	99		18%	10%		EB Holman Hwy	LTRT	210	410		237	440		13%	7%								
											SB On Ramp	RT	50	90		59	99		18%	10%		5							
TOTAL INTERSECTION:			1280	1279	0	1368	1380	0	7%	8%		TOTAL INTERSECTION:			1280	1279		1368	1380		7%	8%							

NEED TO VERIFY FROM RAMP LOS **SB On Ramp Volume:** AM 471 PM 524

Set 1 EB Holman OD Calc

	AM	PM
RT to PB at Int 14:	570	330
From WB Holman Hwy:	10	10
From SB Off-ramp:	480	250
EB T Volume at Int 13:	80	70

Set 2 EB Holman OD Calc

	AM	PM
EB Volume at Int 15:	1025	1183
From SB Off:	20	20
From PB:	237	440
EB T Volume at Int 13:	768	723
EB RT Volume at Int 13:	429	440

- Notes:
- Assumes only cars to PB Gate are Added to Alt 1
  - Assumes no cars exit and re-enter Hwy 1
  - Based on Int 15 - See Set 2 EB Holman OD Calc
  - Based on Int 14 RT - See Set 1 EB Holman OD Calc
  - Set 2 volume based on SB On Ramp Volume from Merge/Diverge worksheets

LEGEND:  
 xxx Input Value  
 xxx Calculated/Linked Value  
 xxx Assumed Value

# Traffic Data Service

Campbell, CA  
 (408) 377-2988  
 tdsbay@cs.com

File Name : 13AM FINAL  
 Site Code : 00000013  
 Start Date : 4/6/2011  
 Page No : 1

### Groups Printed- Vehicles

Start Time	SR-1 SB RAMPS Southbound					SR-68 Westbound					SR-1 SB RAMPS Northbound					SR-68 Eastbound					Int. Total
	Right	Thru	Left	Peds	App. Total	Right	Thru	Left	Peds	App. Total	Right	Thru	Left	Peds	App. Total	Right	Thru	Left	Peds	App. Total	
07:00 AM	101	83	5	0	189	0	42	15	0	57	21	0	5	0	26	52	135	0	0	187	459
07:15 AM	107	92	0	0	199	0	60	12	0	72	29	0	2	0	31	48	160	0	0	208	510
07:30 AM	132	137	2	0	271	0	77	16	0	93	42	0	6	0	48	85	162	0	0	247	659
07:45 AM	144	122	4	0	270	0	98	26	0	124	66	0	11	0	77	79	167	0	0	246	717
<b>Total</b>	<b>484</b>	<b>434</b>	<b>11</b>	<b>0</b>	<b>929</b>	<b>0</b>	<b>277</b>	<b>69</b>	<b>0</b>	<b>346</b>	<b>158</b>	<b>0</b>	<b>24</b>	<b>0</b>	<b>182</b>	<b>264</b>	<b>624</b>	<b>0</b>	<b>0</b>	<b>888</b>	<b>2345</b>
08:00 AM	159	79	2	0	240	0	84	14	0	98	38	0	8	0	46	93	149	0	0	242	626
08:15 AM	141	80	3	0	224	0	93	10	0	103	23	0	5	0	28	101	152	0	0	253	608
08:30 AM	142	84	5	0	231	0	84	13	0	97	30	0	5	0	35	85	140	0	0	225	588
08:45 AM	144	71	4	0	219	0	118	18	0	136	37	0	8	0	45	100	159	0	0	259	659
<b>Total</b>	<b>586</b>	<b>314</b>	<b>14</b>	<b>0</b>	<b>914</b>	<b>0</b>	<b>379</b>	<b>55</b>	<b>0</b>	<b>434</b>	<b>128</b>	<b>0</b>	<b>26</b>	<b>0</b>	<b>154</b>	<b>379</b>	<b>600</b>	<b>0</b>	<b>0</b>	<b>979</b>	<b>2481</b>
<b>Grand Total</b>	<b>1070</b>	<b>748</b>	<b>25</b>	<b>0</b>	<b>1843</b>	<b>0</b>	<b>656</b>	<b>124</b>	<b>0</b>	<b>780</b>	<b>286</b>	<b>0</b>	<b>50</b>	<b>0</b>	<b>336</b>	<b>643</b>	<b>1224</b>	<b>0</b>	<b>0</b>	<b>1867</b>	<b>4826</b>
Apprch %	58.1	40.6	1.4	0		0	84.1	15.9	0		85.1	0	14.9	0		34.4	65.6	0	0		
Total %	22.2	15.5	0.5	0	38.2	0	13.6	2.6	0	16.2	5.9	0	1	0	7	13.3	25.4	0	0	38.7	

Start Time	SR-1 SB RAMPS Southbound					SR-68 Westbound					SR-1 SB RAMPS Northbound					SR-68 Eastbound					Int. Total
	Right	Thru	Left	Peds	App. Total	Right	Thru	Left	Peds	App. Total	Right	Thru	Left	Peds	App. Total	Right	Thru	Left	Peds	App. Total	
Peak Hour Analysis From 07:00 AM to 08:45 AM - Peak 1 of 1																					
Peak Hour for Entire Intersection Begins at 07:30 AM																					
07:30 AM	132	137	2	0	271	0	77	16	0	93	42	0	6	0	48	85	162	0	0	247	659
07:45 AM	144	122	4	0	270	0	98	26	0	124	66	0	11	0	77	79	167	0	0	246	717
08:00 AM	159	79	2	0	240	0	84	14	0	98	38	0	8	0	46	93	149	0	0	242	626
08:15 AM	141	80	3	0	224	0	93	10	0	103	23	0	5	0	28	101	152	0	0	253	608
Total Volume	576	418	11	0	1005	0	352	66	0	418	169	0	30	0	199	358	630	0	0	988	2610
% App. Total	57.3	41.6	1.1	0		0	84.2	15.8	0		84.9	0	15.1	0		36.2	63.8	0	0		
PHF	.906	.763	.688	.000	.927	.000	.898	.635	.000	.843	.640	.000	.682	.000	.646	.886	.943	.000	.000	.976	.910

# Traffic Data Service

Campbell, CA  
 (408) 377-2988  
 tdsbay@cs.com

File Name : 13AM FINAL  
 Site Code : 00000013  
 Start Date : 4/6/2011  
 Page No : 2

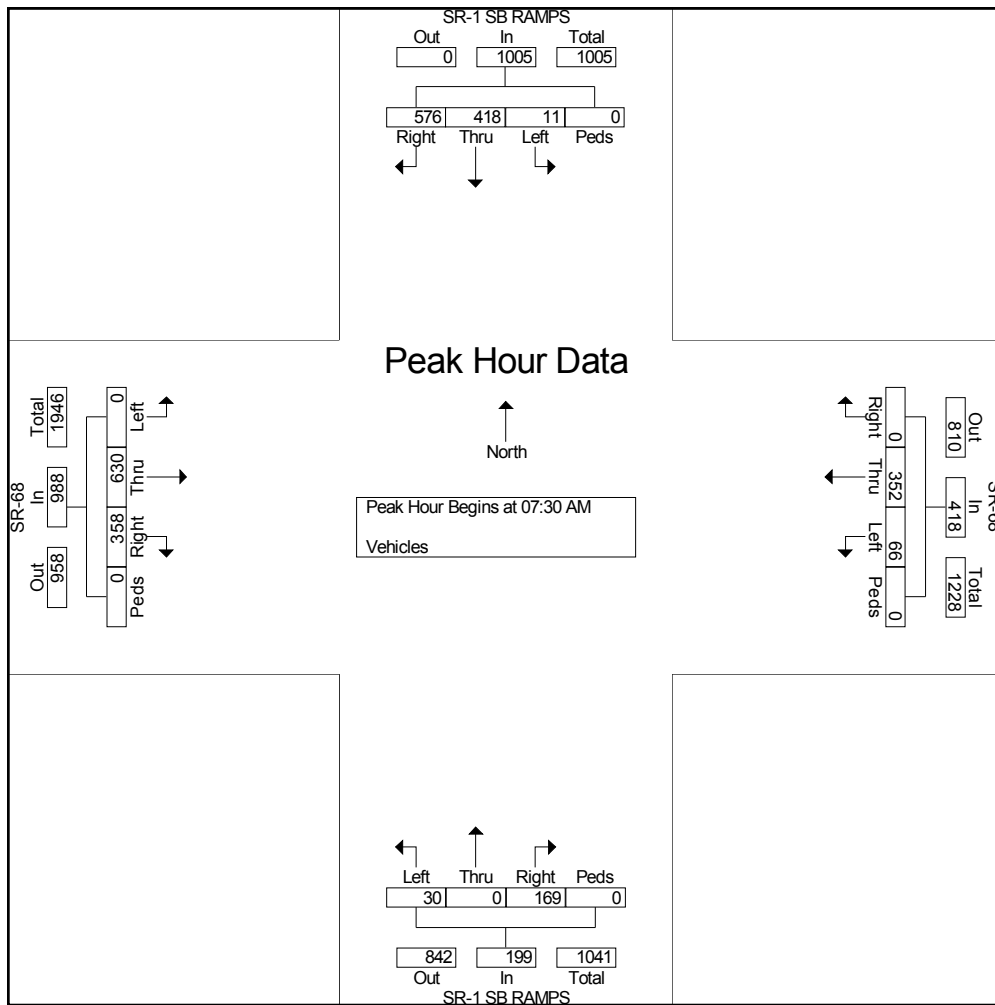



# Traffic Data Service

Campbell, CA  
(408) 377-2988  
tdsbay@cs.com

File Name : 13PM FINAL  
Site Code : 00000013  
Start Date : 4/6/2011  
Page No : 1

### Groups Printed- Vehicles

Start Time	SR-1 SB RAMPS Southbound					SR-68 Westbound					SR-1 SB RAMPS Northbound					SR-68 Eastbound					Int. Total
	Right	Thru	Left	Peds	App. Total	Right	Thru	Left	Peds	App. Total	Right	Thru	Left	Peds	App. Total	Right	Thru	Left	Peds	App. Total	
04:00 PM	120	60	1	0	181	0	95	16	0	111	88	0	7	0	95	81	177	0	0	258	645
04:15 PM	137	63	4	0	204	0	87	16	0	103	73	0	2	0	75	85	167	0	0	252	634
04:30 PM	158	52	2	0	212	0	97	13	0	110	109	0	1	0	110	87	160	0	0	247	679
04:45 PM	156	47	3	0	206	0	82	17	0	99	74	0	6	0	80	99	159	0	0	258	643
<b>Total</b>	<b>571</b>	<b>222</b>	<b>10</b>	<b>0</b>	<b>803</b>	<b>0</b>	<b>361</b>	<b>62</b>	<b>0</b>	<b>423</b>	<b>344</b>	<b>0</b>	<b>16</b>	<b>0</b>	<b>360</b>	<b>352</b>	<b>663</b>	<b>0</b>	<b>0</b>	<b>1015</b>	<b>2601</b>
05:00 PM	171	61	0	0	232	0	83	15	0	98	86	0	10	0	96	88	155	0	2	245	671
05:15 PM	196	54	4	0	254	0	127	17	0	144	83	0	8	0	91	104	141	0	0	245	734
05:30 PM	180	72	9	0	261	0	105	17	0	122	63	0	4	0	67	77	143	0	1	221	671
05:45 PM	169	44	2	0	215	0	78	20	0	98	74	0	6	0	80	95	144	0	0	239	632
<b>Total</b>	<b>716</b>	<b>231</b>	<b>15</b>	<b>0</b>	<b>962</b>	<b>0</b>	<b>393</b>	<b>69</b>	<b>0</b>	<b>462</b>	<b>306</b>	<b>0</b>	<b>28</b>	<b>0</b>	<b>334</b>	<b>364</b>	<b>583</b>	<b>0</b>	<b>3</b>	<b>950</b>	<b>2708</b>
<b>Grand Total</b>	<b>1287</b>	<b>453</b>	<b>25</b>	<b>0</b>	<b>1765</b>	<b>0</b>	<b>754</b>	<b>131</b>	<b>0</b>	<b>885</b>	<b>650</b>	<b>0</b>	<b>44</b>	<b>0</b>	<b>694</b>	<b>716</b>	<b>1246</b>	<b>0</b>	<b>3</b>	<b>1965</b>	<b>5309</b>
Apprch %	72.9	25.7	1.4	0		0	85.2	14.8	0		93.7	0	6.3	0		36.4	63.4	0	0.2		
Total %	24.2	8.5	0.5	0	33.2	0	14.2	2.5	0	16.7	12.2	0	0.8	0	13.1	13.5	23.5	0	0.1	37	

Start Time	SR-1 SB RAMPS Southbound					SR-68 Westbound					SR-1 SB RAMPS Northbound					SR-68 Eastbound					Int. Total
	Right	Thru	Left	Peds	App. Total	Right	Thru	Left	Peds	App. Total	Right	Thru	Left	Peds	App. Total	Right	Thru	Left	Peds	App. Total	
Peak Hour Analysis From 04:00 PM to 05:45 PM - Peak 1 of 1																					
Peak Hour for Entire Intersection Begins at 04:30 PM																					
04:30 PM	158	52	2	0	212	0	97	13	0	110	109	0	1	0	110	87	160	0	0	247	679
04:45 PM	156	47	3	0	206	0	82	17	0	99	74	0	6	0	80	99	159	0	0	258	643
05:00 PM	171	61	0	0	232	0	83	15	0	98	86	0	10	0	96	88	155	0	2	245	671
05:15 PM	196	54	4	0	254	0	127	17	0	144	83	0	8	0	91	104	141	0	0	245	734
<b>Total Volume</b>	<b>681</b>	<b>214</b>	<b>9</b>	<b>0</b>	<b>904</b>	<b>0</b>	<b>389</b>	<b>62</b>	<b>0</b>	<b>451</b>	<b>352</b>	<b>0</b>	<b>25</b>	<b>0</b>	<b>377</b>	<b>378</b>	<b>615</b>	<b>0</b>	<b>2</b>	<b>995</b>	<b>2727</b>
% App. Total	75.3	23.7	1	0		0	86.3	13.7	0		93.4	0	6.6	0		38	61.8	0	0.2		
PHF	.869	.877	.563	.000	.890	.000	.766	.912	.000	.783	.807	.000	.625	.000	.857	.909	.961	.000	.250	.964	.929

# Traffic Data Service

Campbell, CA  
 (408) 377-2988  
 tdsbay@cs.com

File Name : 13PM FINAL  
 Site Code : 00000013  
 Start Date : 4/6/2011  
 Page No : 2

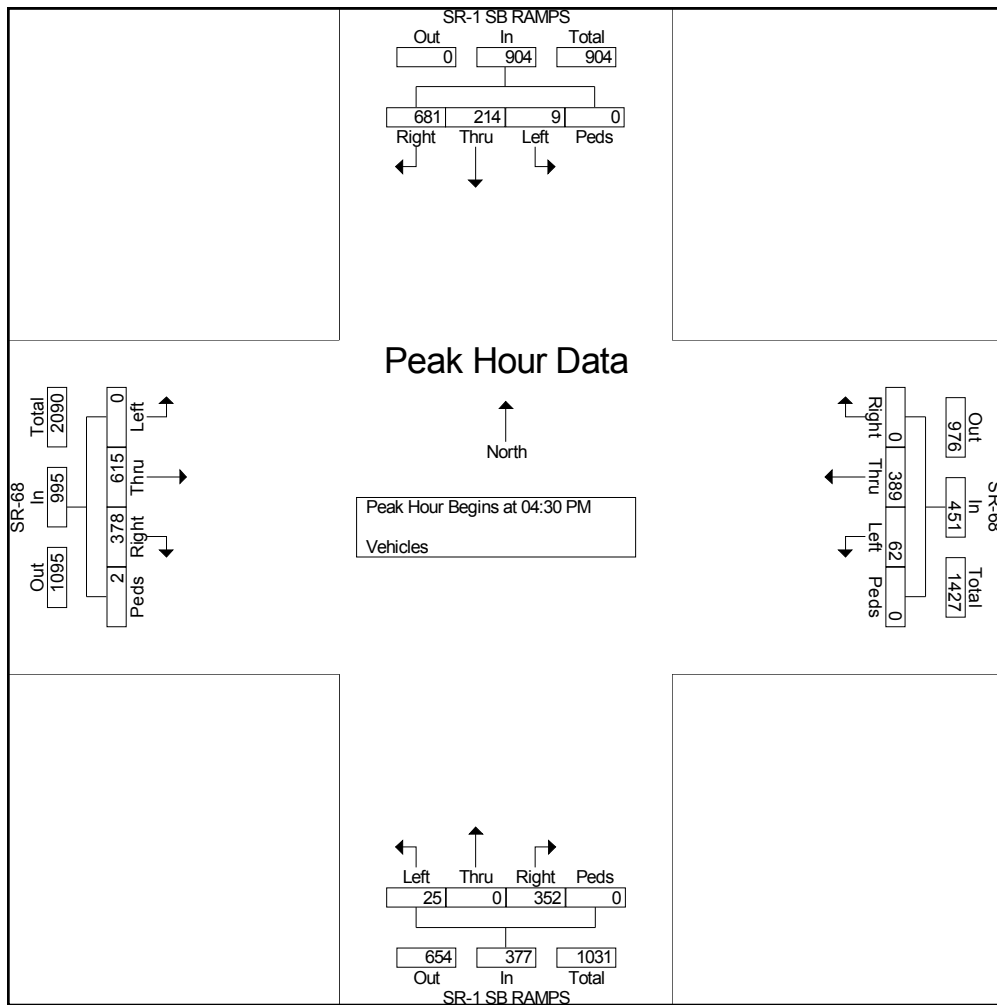

# Traffic Data Service

Campbell, CA  
(408) 377-2988  
tdsbay@cs.com

File Name : 14AM FINAL  
Site Code : 00000014  
Start Date : 4/6/2011  
Page No : 1

### Groups Printed- Vehicles

Start Time	SR-1/SR-68 SB ON-RAMP Southbound					Westbound					Northbound					17-MILE RD Eastbound					Int. Total
	Right	Thru	Left	Peds	App. Total	Right	Thru	Left	Peds	App. Total	Right	Thru	Left	Peds	App. Total	Right	Thru	Left	Peds	App. Total	
07:00 AM	86	52	0	0	138	0	0	0	0	0	0	0	0	0	0	8	0	26	0	34	172
07:15 AM	87	57	0	0	144	0	0	0	0	0	0	0	0	0	0	7	0	29	0	36	180
07:30 AM	152	88	0	0	240	0	0	0	0	0	0	0	0	0	0	19	0	53	0	72	312
07:45 AM	138	89	0	0	227	0	0	0	0	0	0	0	0	0	0	8	0	86	0	94	321
<b>Total</b>	<b>463</b>	<b>286</b>	<b>0</b>	<b>0</b>	<b>749</b>	<b>0</b>	<b>0</b>	<b>0</b>	<b>0</b>	<b>0</b>	<b>0</b>	<b>0</b>	<b>0</b>	<b>0</b>	<b>0</b>	<b>42</b>	<b>0</b>	<b>194</b>	<b>0</b>	<b>236</b>	<b>985</b>
08:00 AM	106	90	0	0	196	0	0	0	0	0	0	0	0	0	0	4	0	50	0	54	250
08:15 AM	108	95	0	0	203	0	0	0	0	0	0	0	0	0	0	7	0	41	0	48	251
08:30 AM	101	82	0	0	183	0	0	0	0	0	0	0	0	0	0	13	0	41	0	54	237
08:45 AM	108	92	0	0	200	0	0	0	0	0	0	0	0	0	0	14	0	69	0	83	283
<b>Total</b>	<b>423</b>	<b>359</b>	<b>0</b>	<b>0</b>	<b>782</b>	<b>0</b>	<b>0</b>	<b>0</b>	<b>0</b>	<b>0</b>	<b>0</b>	<b>0</b>	<b>0</b>	<b>0</b>	<b>0</b>	<b>38</b>	<b>0</b>	<b>201</b>	<b>0</b>	<b>239</b>	<b>1021</b>
<b>Grand Total</b>	<b>886</b>	<b>645</b>	<b>0</b>	<b>0</b>	<b>1531</b>	<b>0</b>	<b>0</b>	<b>0</b>	<b>0</b>	<b>0</b>	<b>0</b>	<b>0</b>	<b>0</b>	<b>0</b>	<b>0</b>	<b>80</b>	<b>0</b>	<b>395</b>	<b>0</b>	<b>475</b>	<b>2006</b>
Apprch %	57.9	42.1	0	0		0	0	0	0		0	0	0	0		16.8	0	83.2	0		
Total %	44.2	32.2	0	0	76.3	0	0	0	0	0	0	0	0	0	0	4	0	19.7	0	23.7	

Start Time	SR-1/SR-68 SB ON-RAMP Southbound					Westbound					Northbound					17-MILE RD Eastbound					Int. Total
	Right	Thru	Left	Peds	App. Total	Right	Thru	Left	Peds	App. Total	Right	Thru	Left	Peds	App. Total	Right	Thru	Left	Peds	App. Total	
Peak Hour Analysis From 07:00 AM to 08:45 AM - Peak 1 of 1																					
Peak Hour for Entire Intersection Begins at 07:30 AM																					
07:30 AM	152	88	0	0	240	0	0	0	0	0	0	0	0	0	0	19	0	53	0	72	312
07:45 AM	138	89	0	0	227	0	0	0	0	0	0	0	0	0	0	8	0	86	0	94	321
08:00 AM	106	90	0	0	196	0	0	0	0	0	0	0	0	0	0	4	0	50	0	54	250
08:15 AM	108	95	0	0	203	0	0	0	0	0	0	0	0	0	0	7	0	41	0	48	251
Total Volume	504	362	0	0	866	0	0	0	0	0	0	0	0	0	0	38	0	230	0	268	1134
% App. Total	58.2	41.8	0	0		0	0	0	0		0	0	0	0		14.2	0	85.8	0		
PHF	.829	.953	.000	.000	.902	.000	.000	.000	.000	.000	.000	.000	.000	.000	.000	.500	.000	.669	.000	.713	.883

# Traffic Data Service

Campbell, CA  
 (408) 377-2988  
 tdsbay@cs.com

File Name : 14AM FINAL  
 Site Code : 00000014  
 Start Date : 4/6/2011  
 Page No : 2

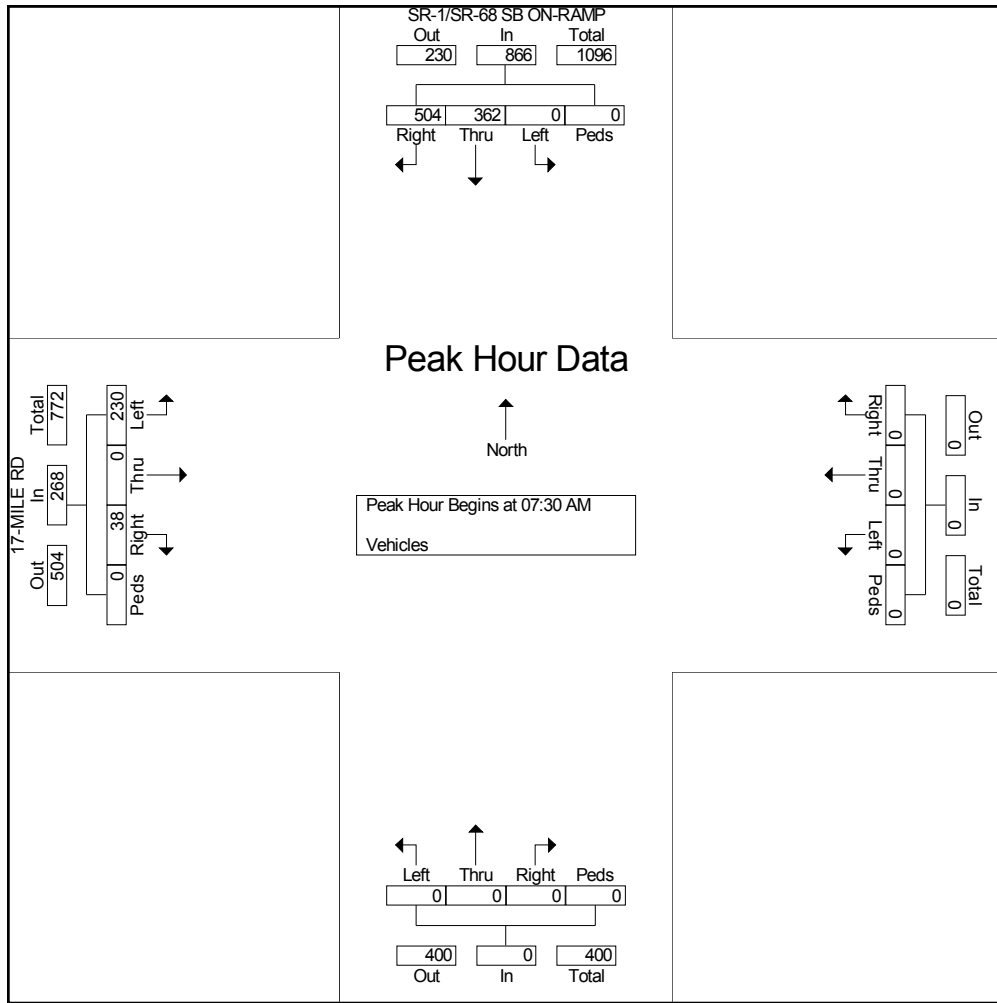

# Traffic Data Service

Campbell, CA  
(408) 377-2988  
tdsbay@cs.com

File Name : 14PM FINAL  
Site Code : 00000014  
Start Date : 4/6/2011  
Page No : 1

### Groups Printed- Vehicles

Start Time	SR-1/SR-68 SB ON-RAMP Southbound					Westbound					Northbound					17-MILE RD Eastbound					Int. Total
	Right	Thru	Left	Peds	App. Total	Right	Thru	Left	Peds	App. Total	Right	Thru	Left	Peds	App. Total	Right	Thru	Left	Peds	App. Total	
04:00 PM	77	87	0	0	164	0	0	0	0	0	0	0	0	0	0	12	0	101	0	113	277
04:15 PM	78	84	0	0	162	0	0	0	0	0	0	0	0	0	0	17	0	89	0	106	268
04:30 PM	66	86	0	0	152	0	0	0	0	0	0	0	0	0	0	18	0	115	0	133	285
04:45 PM	69	90	0	0	159	0	0	0	0	0	0	0	0	0	0	22	0	89	0	111	270
<b>Total</b>	<b>290</b>	<b>347</b>	<b>0</b>	<b>0</b>	<b>637</b>	<b>0</b>	<b>0</b>	<b>0</b>	<b>0</b>	<b>0</b>	<b>0</b>	<b>0</b>	<b>0</b>	<b>0</b>	<b>0</b>	<b>69</b>	<b>0</b>	<b>394</b>	<b>0</b>	<b>463</b>	<b>1100</b>
05:00 PM	76	86	0	0	162	0	0	0	0	0	0	0	0	0	0	21	0	96	0	117	279
05:15 PM	70	99	0	0	169	0	0	0	0	0	0	0	0	0	0	12	1	84	0	97	266
05:30 PM	91	74	0	0	165	0	0	0	0	0	0	0	0	0	0	13	0	80	0	93	258
05:45 PM	71	87	0	0	158	0	0	0	0	0	0	0	0	0	0	14	0	83	0	97	255
<b>Total</b>	<b>308</b>	<b>346</b>	<b>0</b>	<b>0</b>	<b>654</b>	<b>0</b>	<b>0</b>	<b>0</b>	<b>0</b>	<b>0</b>	<b>0</b>	<b>0</b>	<b>0</b>	<b>0</b>	<b>0</b>	<b>60</b>	<b>1</b>	<b>343</b>	<b>0</b>	<b>404</b>	<b>1058</b>
<b>Grand Total</b>	<b>598</b>	<b>693</b>	<b>0</b>	<b>0</b>	<b>1291</b>	<b>0</b>	<b>0</b>	<b>0</b>	<b>0</b>	<b>0</b>	<b>0</b>	<b>0</b>	<b>0</b>	<b>0</b>	<b>0</b>	<b>129</b>	<b>1</b>	<b>737</b>	<b>0</b>	<b>867</b>	<b>2158</b>
Apprch %	46.3	53.7	0	0		0	0	0	0	0	0	0	0	0	0	14.9	0.1	85	0		
Total %	27.7	32.1	0	0	59.8	0	0	0	0	0	0	0	0	0	0	6	0	34.2	0	40.2	

Start Time	SR-1/SR-68 SB ON-RAMP Southbound					Westbound					Northbound					17-MILE RD Eastbound					Int. Total
	Right	Thru	Left	Peds	App. Total	Right	Thru	Left	Peds	App. Total	Right	Thru	Left	Peds	App. Total	Right	Thru	Left	Peds	App. Total	
Peak Hour Analysis From 04:00 PM to 05:45 PM - Peak 1 of 1																					
Peak Hour for Entire Intersection Begins at 04:15 PM																					
04:15 PM	78	84	0	0	162	0	0	0	0	0	0	0	0	0	0	17	0	89	0	106	268
04:30 PM	66	86	0	0	152	0	0	0	0	0	0	0	0	0	0	18	0	115	0	133	285
04:45 PM	69	90	0	0	159	0	0	0	0	0	0	0	0	0	0	22	0	89	0	111	270
05:00 PM	76	86	0	0	162	0	0	0	0	0	0	0	0	0	0	21	0	96	0	117	279
<b>Total Volume</b>	<b>289</b>	<b>346</b>	<b>0</b>	<b>0</b>	<b>635</b>	<b>0</b>	<b>0</b>	<b>0</b>	<b>0</b>	<b>0</b>	<b>0</b>	<b>0</b>	<b>0</b>	<b>0</b>	<b>0</b>	<b>78</b>	<b>0</b>	<b>389</b>	<b>0</b>	<b>467</b>	<b>1102</b>
% App. Total	45.5	54.5	0	0		0	0	0	0	0	0	0	0	0	0	16.7	0	83.3	0		
PHF	.926	.961	.000	.000	.980	.000	.000	.000	.000	.000	.000	.000	.000	.000	.000	.886	.000	.846	.000	.878	.967

# Traffic Data Service

Campbell, CA  
 (408) 377-2988  
 tdsbay@cs.com

File Name : 14PM FINAL  
 Site Code : 00000014  
 Start Date : 4/6/2011  
 Page No : 2

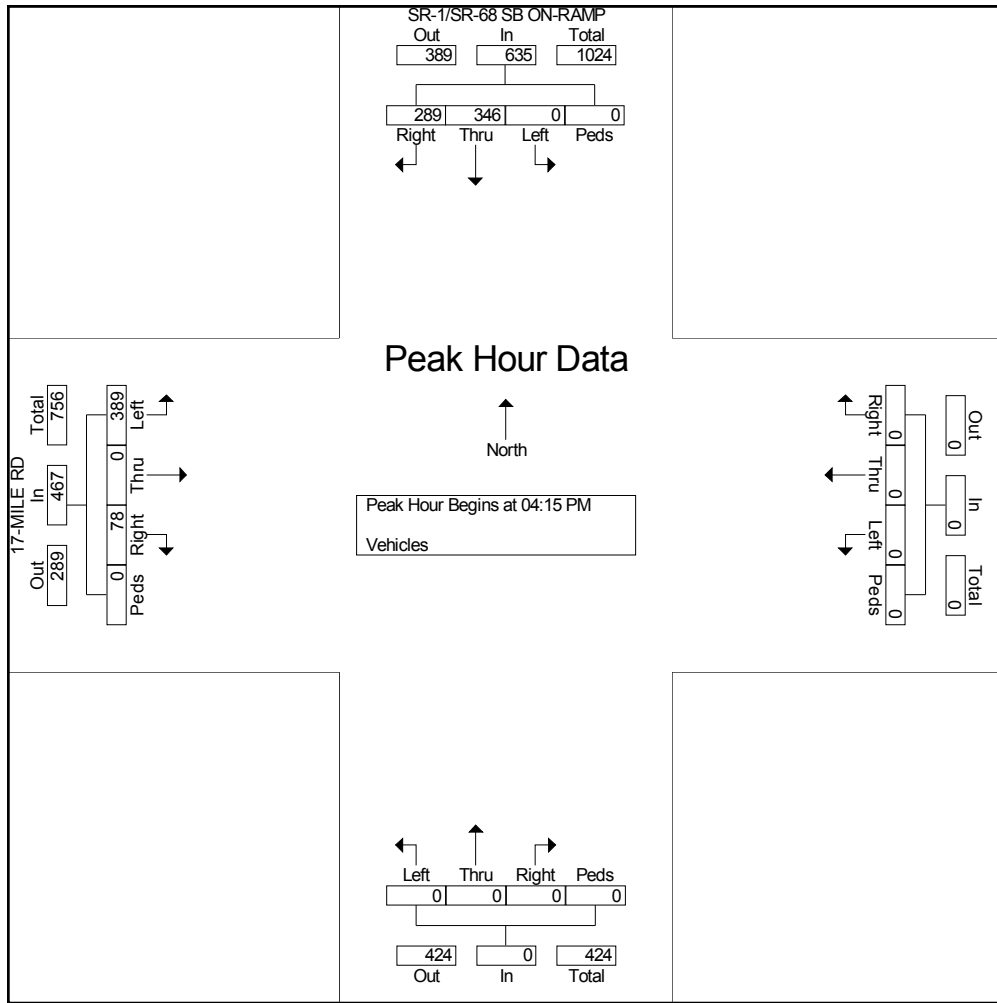

# Traffic Data Service

Campbell, CA  
 (408) 377-2988  
 tdsbay@cs.com

File Name : 12AM FINAL  
 Site Code : 00000012  
 Start Date : 4/6/2011  
 Page No : 2

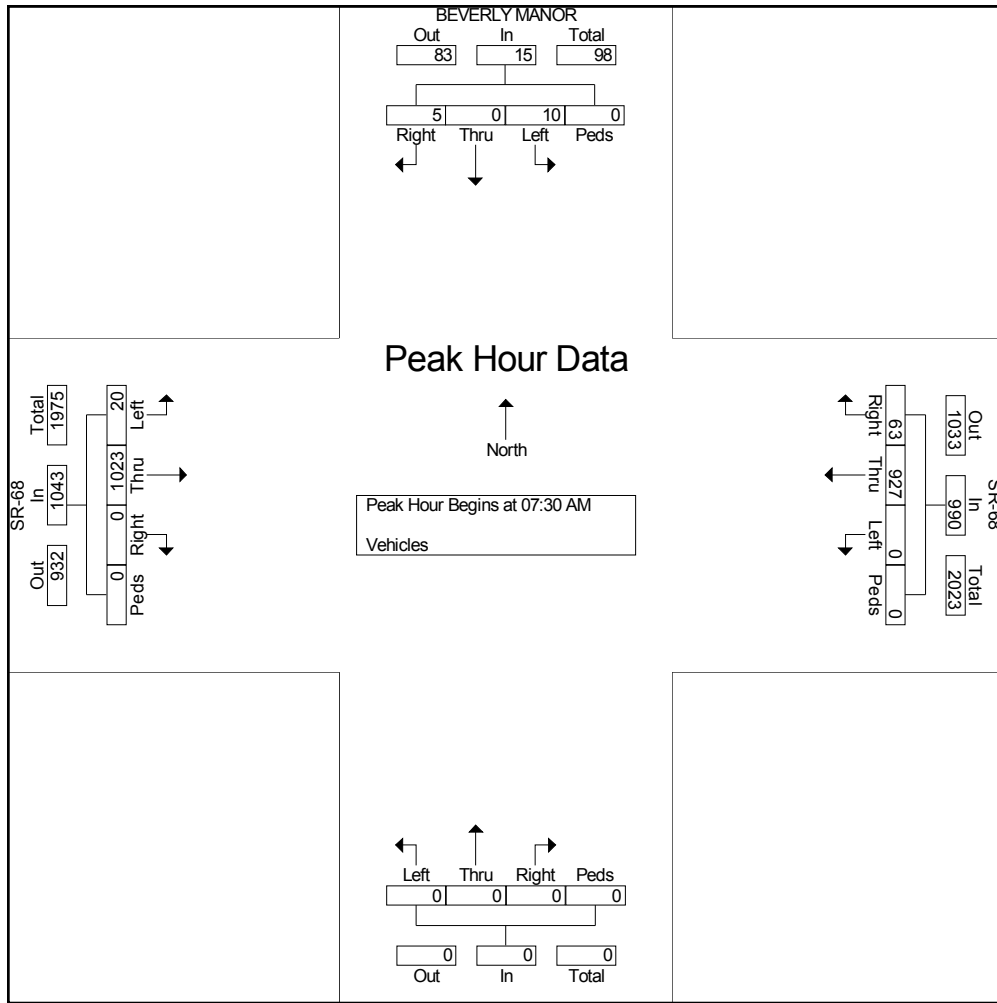



# Traffic Data Service

Campbell, CA  
 (408) 377-2988  
 tdsbay@cs.com

File Name : 12PM FINAL  
 Site Code : 00000012  
 Start Date : 4/6/2011  
 Page No : 2

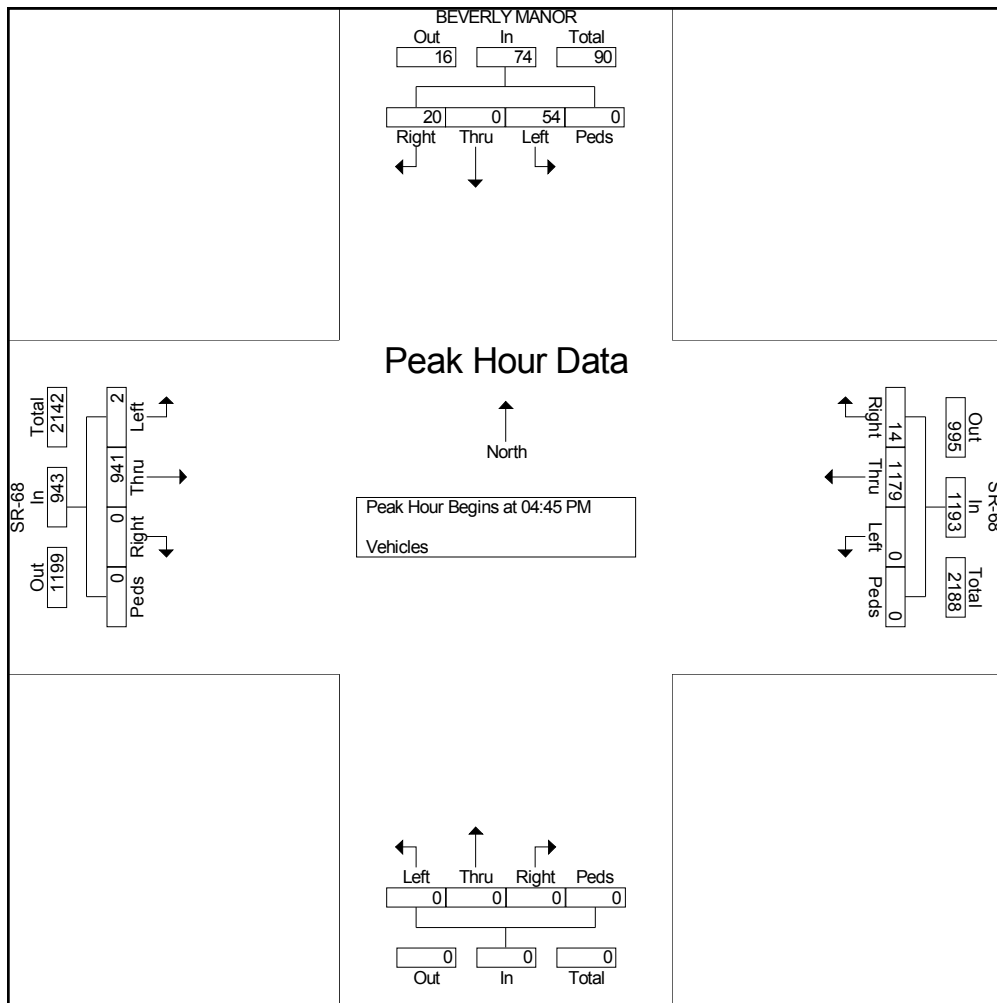

Attachment B  
Monterey County Bicycle Maps



Figure 2-6: Existing Bicycle Network Monterey Bay Area



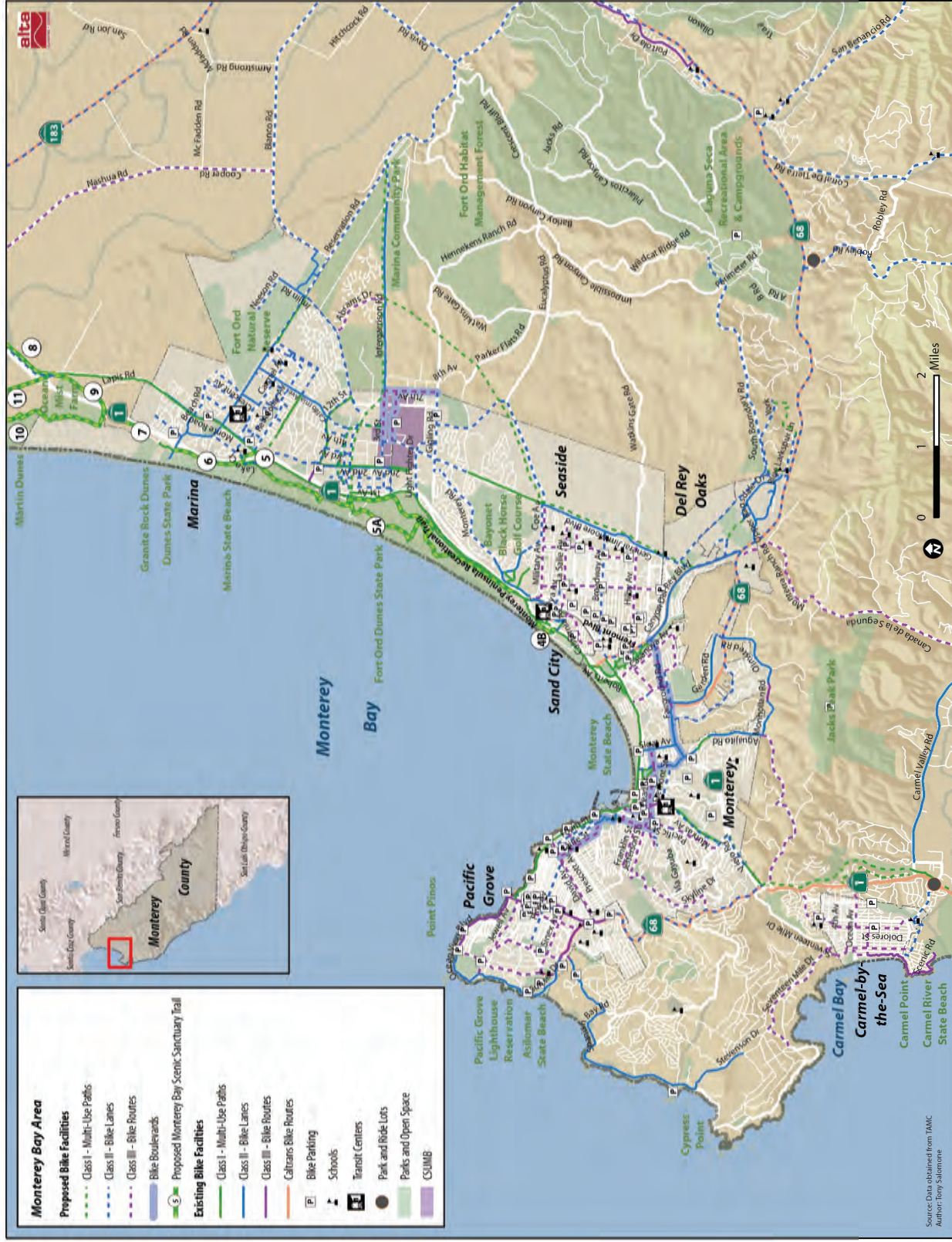

Figure 6-2: County of Monterey Bikeway Projects (Peninsula)





Figure 6-10: City of Monterey Bikeway Projects

Attachment C  
Roundabout Performance  
Checks





Vehicle Natural Path Alignment  
Eastbound Two Lane Entry  
SR 68/SR 1 Ramp Termini Intersection  
Interim Roundabout Configuration

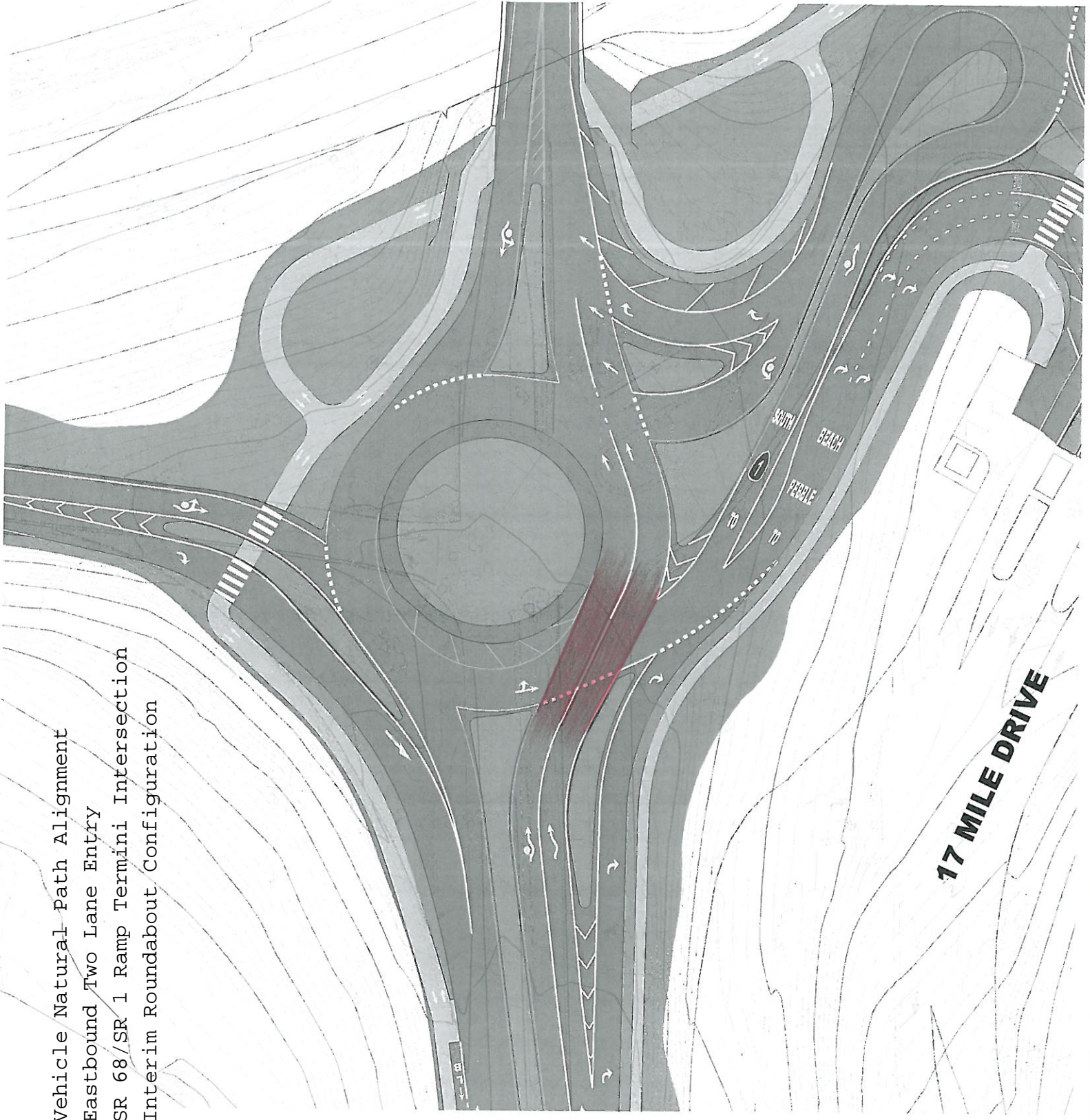

**17 MILE DRIVE**



Composite Sight Distance Exhibit  
Interim Roundabout Configuration

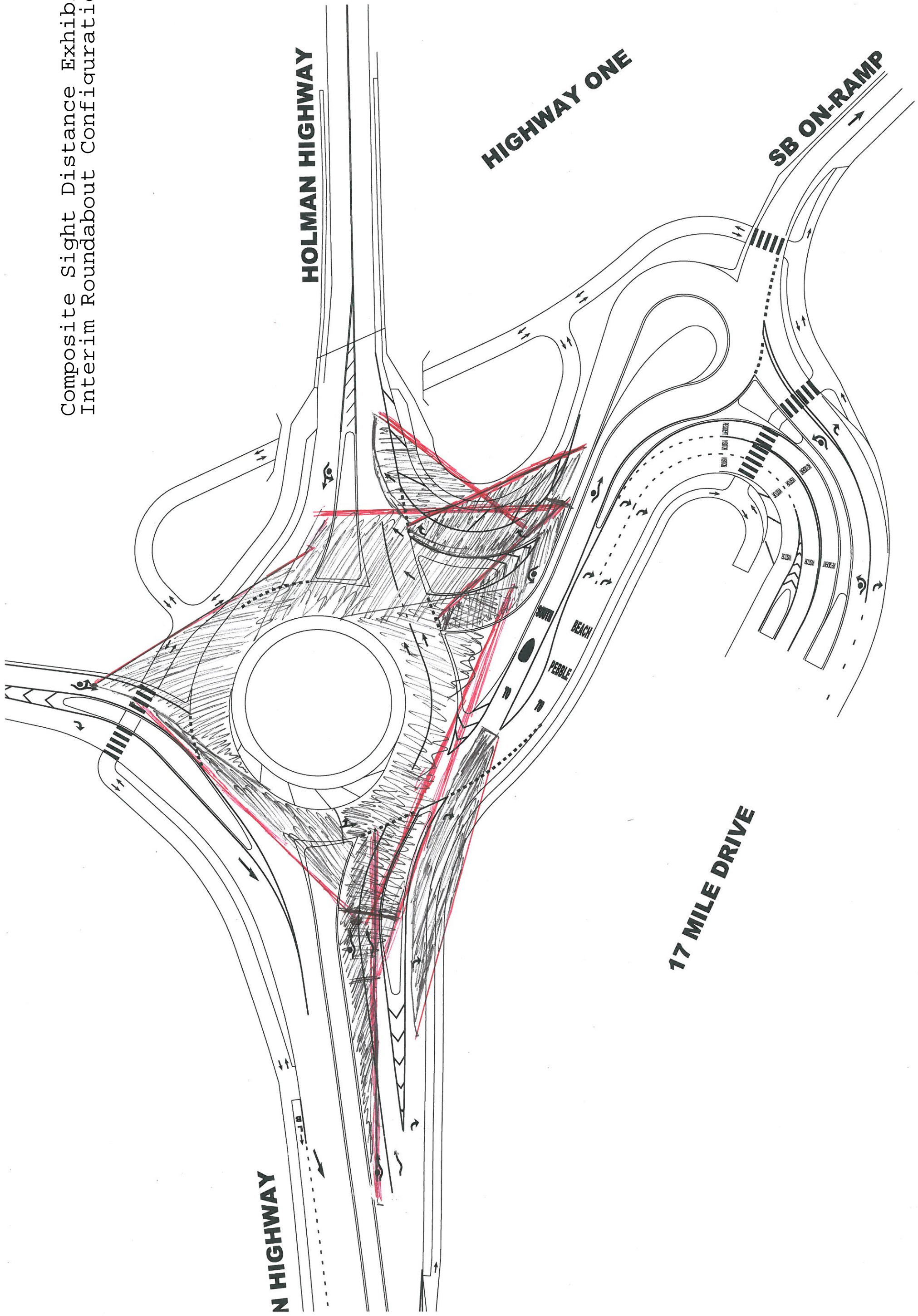

Attachment D  
Signal Operations Analysis

# HCM Signalized Intersection Capacity Analysis

## 1: Pebble Beach/Highway 1 SB Off-ramp & Highway 1 SB On-ramp & Holman Hwy

3/7/2013

Movement	EBT	EBR	EBR2	WBL2	WBL	WBT	NBL	NBR	SBL2	SBT	SBR	
Lane Configurations	↑	↗			↖	↑	↖	↗	↖	↗		
Volume (vph)	688	373	17	10	79	376	44	217	20	460	617	
Ideal Flow (vphpl)	1900	1900	1900	1900	1900	1900	1900	1900	1900	1900	1900	
Total Lost time (s)	4.0	4.0			4.0	4.0	4.0	4.0	4.0	4.0		
Lane Util. Factor	1.00	1.00			1.00	1.00	1.00	1.00	1.00	1.00		
Fr <sub>t</sub>	1.00	0.85			1.00	1.00	1.00	0.85	1.00	0.91		
Fl <sub>t</sub> Protected	1.00	1.00			0.95	1.00	0.95	1.00	0.95	1.00		
Satd. Flow (prot)	1863	1583			1770	1863	1770	1583	1770	1703		
Fl <sub>t</sub> Permitted	1.00	1.00			0.95	1.00	0.95	1.00	0.95	1.00		
Satd. Flow (perm)	1863	1583			1770	1863	1770	1583	1770	1703		
Peak-hour factor, PHF	0.92	0.92	0.92	0.92	0.92	0.92	0.92	0.92	0.92	0.92	0.92	
Adj. Flow (vph)	748	405	18	11	86	409	48	236	22	500	671	
RTOR Reduction (vph)	0	0	0	0	0	0	0	0	0	54	0	
Lane Group Flow (vph)	748	423	0	0	97	409	48	236	22	1117	0	
Turn Type	NA	Perm		Prot	Prot	NA	Prot	custom	Split	NA		
Protected Phases	4			3	3	8	5		6	6		
Permitted Phases		4						2				
Actuated Green, G (s)	26.0	26.0			4.0	34.0	4.0	48.0	40.0	40.0		
Effective Green, g (s)	26.0	26.0			4.0	34.0	4.0	48.0	40.0	40.0		
Actuated g/C Ratio	0.29	0.29			0.04	0.38	0.04	0.53	0.44	0.44		
Clearance Time (s)	4.0	4.0			4.0	4.0	4.0	4.0	4.0	4.0		
Vehicle Extension (s)	3.0	3.0			3.0	3.0	3.0	3.0	3.0	3.0		
Lane Grp Cap (vph)	538	457			78	703	78	844	786	756		
v/s Ratio Prot	c0.40				c0.05	0.22	c0.03		0.01	c0.66		
v/s Ratio Perm		0.27						0.15				
v/c Ratio	1.39	0.93			1.24	0.58	0.62	0.28	0.03	1.48		
Uniform Delay, d <sub>1</sub>	32.0	31.1			43.0	22.3	42.2	11.5	14.1	25.0		
Progression Factor	1.00	1.00			1.00	1.00	1.00	1.00	1.00	1.00		
Incremental Delay, d <sub>2</sub>	186.9	27.1			181.0	1.2	13.6	0.2	0.0	222.1		
Delay (s)	218.9	58.1			224.0	23.6	55.8	11.7	14.1	247.1		
Level of Service	F	E			F	C	E	B	B	F		
Approach Delay (s)	160.8					62.0				242.8		
Approach LOS	F					E				F		
<b>Intersection Summary</b>												
HCM 2000 Control Delay			163.2								HCM 2000 Level of Service	F
HCM 2000 Volume to Capacity ratio			1.39									
Actuated Cycle Length (s)			90.0								Sum of lost time (s)	16.0
Intersection Capacity Utilization			113.2%								ICU Level of Service	H
Analysis Period (min)			15									
c Critical Lane Group												

# Queues

## 1: Pebble Beach/Highway 1 SB Off-ramp & Highway 1 SB On-ramp & Holman Hwy

3/7/2013

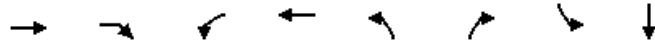

Lane Group	EBT	EBR	WBL	WBT	NBL	NBR	SBL2	SBT
Lane Group Flow (vph)	748	423	97	409	48	236	22	1171
v/c Ratio	1.39	0.93	1.24	0.58	0.62	0.28	0.03	1.45
Control Delay	215.5	60.1	220.2	26.4	75.7	12.6	14.3	230.8
Queue Delay	0.0	0.0	0.0	0.0	0.0	0.0	0.0	0.0
Total Delay	215.5	60.1	220.2	26.4	75.7	12.6	14.3	230.8
Queue Length 50th (ft)	~572	233	~69	182	27	69	7	~891
Queue Length 95th (ft)	#790	#412	#167	276	#82	115	20	#1139
Internal Link Dist (ft)	908			497				387
Turn Bay Length (ft)		200	200		50		200	
Base Capacity (vph)	538	457	78	703	78	844	786	810
Starvation Cap Reductn	0	0	0	0	0	0	0	0
Spillback Cap Reductn	0	0	0	0	0	0	0	0
Storage Cap Reductn	0	0	0	0	0	0	0	0
Reduced v/c Ratio	1.39	0.93	1.24	0.58	0.62	0.28	0.03	1.45





















### Intersection Summary

- ~ Volume exceeds capacity, queue is theoretically infinite.  
Queue shown is maximum after two cycles.
- # 95th percentile volume exceeds capacity, queue may be longer.  
Queue shown is maximum after two cycles.

# HCM Signalized Intersection Capacity Analysis

## 1: Pebble Beach/Highway 1 SB Off-ramp & Highway 1 SB On-ramp & Holman Hwy

3/7/2013

												
Movement	EBT	EBR	EBR2	WBL2	WBL	WBT	NBL	NBR	SBL2	SBT	SBR	
Lane Configurations												
Volume (vph)	647	376	25	10	70	393	37	400	10	254	730	
Ideal Flow (vphpl)	1900	1900	1900	1900	1900	1900	1900	1900	1900	1900	1900	
Total Lost time (s)	4.0	4.0			4.0	4.0	4.0	4.0	4.0	4.0	4.0	
Lane Util. Factor	1.00	1.00			1.00	1.00	1.00	1.00	1.00	1.00	1.00	
Flt	1.00	0.85			1.00	1.00	1.00	0.85	1.00	1.00	0.85	
Flt Protected	1.00	1.00			0.95	1.00	0.95	1.00	0.95	1.00	1.00	
Satd. Flow (prot)	1863	1583			1770	1863	1770	1583	1770	1863	1583	
Flt Permitted	1.00	1.00			0.95	1.00	0.95	1.00	0.95	1.00	1.00	
Satd. Flow (perm)	1863	1583			1770	1863	1770	1583	1770	1863	1583	
Peak-hour factor, PHF	0.92	0.92	0.92	0.92	0.92	0.92	0.92	0.92	0.92	0.92	0.92	
Adj. Flow (vph)	703	409	27	11	76	427	40	435	11	276	793	
RTOR Reduction (vph)	0	0	0	0	0	0	0	0	0	0	215	
Lane Group Flow (vph)	703	436	0	0	87	427	40	435	11	276	578	
Turn Type	NA	Perm		Prot	Prot	NA	Prot	custom	Split	NA	Perm	
Protected Phases	4			3	3	8	5		6	6		
Permitted Phases		4						2			6	
Actuated Green, G (s)	33.0	33.0			5.0	42.0	4.0	40.0	32.0	32.0	32.0	
Effective Green, g (s)	33.0	33.0			5.0	42.0	4.0	40.0	32.0	32.0	32.0	
Actuated g/C Ratio	0.37	0.37			0.06	0.47	0.04	0.44	0.36	0.36	0.36	
Clearance Time (s)	4.0	4.0			4.0	4.0	4.0	4.0	4.0	4.0	4.0	
Vehicle Extension (s)	3.0	3.0			3.0	3.0	3.0	3.0	3.0	3.0	3.0	
Lane Grp Cap (vph)	683	580			98	869	78	703	629	662	562	
v/s Ratio Prot	c0.38				c0.05	0.23	0.02		0.01	0.15		
v/s Ratio Perm		0.28						c0.27			c0.36	
v/c Ratio	1.03	0.75			0.89	0.49	0.51	0.62	0.02	0.42	1.03	
Uniform Delay, d1	28.5	24.9			42.2	16.6	42.0	19.2	18.8	21.9	29.0	
Progression Factor	1.00	1.00			1.00	1.00	1.00	1.00	1.00	1.00	1.00	
Incremental Delay, d2	42.1	8.7			55.8	0.4	5.6	1.6	0.0	0.4	45.3	
Delay (s)	70.6	33.6			98.0	17.0	47.6	20.8	18.8	22.4	74.3	
Level of Service	E	C			F	B	D	C	B	C	E	
Approach Delay (s)	56.5					30.7				60.5		
Approach LOS	E					C				E		
<b>Intersection Summary</b>												
HCM 2000 Control Delay			48.8		HCM 2000 Level of Service				D			
HCM 2000 Volume to Capacity ratio			1.01									
Actuated Cycle Length (s)			90.0		Sum of lost time (s)				16.0			
Intersection Capacity Utilization			79.9%		ICU Level of Service				D			
Analysis Period (min)			15									
c Critical Lane Group												



# Queues

## 1: Pebble Beach/Highway 1 SB Off-ramp & Highway 1 SB On-ramp & Holman Hwy

3/7/2013



Lane Group	EBT	EBR	WBL	WBT	NBL	NBR	SBL2	SBT	SBR
Lane Group Flow (vph)	703	436	87	427	40	435	11	276	793
v/c Ratio	1.03	0.75	0.89	0.49	0.51	0.62	0.02	0.42	1.02
Control Delay	72.2	34.7	109.7	19.1	65.6	23.9	19.0	24.4	55.9
Queue Delay	0.0	0.0	0.0	0.0	0.0	0.0	0.0	0.0	0.0
Total Delay	72.2	34.7	109.7	19.1	65.6	23.9	19.0	24.4	55.9
Queue Length 50th (ft)	~432	213	50	162	23	184	4	117	~323
Queue Length 95th (ft)	#645	#339	#140	245	#67	285	15	186	#574
Internal Link Dist (ft)	908			497				387	
Turn Bay Length (ft)		200	200		50		200		
Base Capacity (vph)	683	580	98	869	78	703	629	662	778
Starvation Cap Reductn	0	0	0	0	0	0	0	0	0
Spillback Cap Reductn	0	0	0	0	0	0	0	0	0
Storage Cap Reductn	0	0	0	0	0	0	0	0	0
Reduced v/c Ratio	1.03	0.75	0.89	0.49	0.51	0.62	0.02	0.42	1.02





















### Intersection Summary

- ~ Volume exceeds capacity, queue is theoretically infinite.  
Queue shown is maximum after two cycles.
- # 95th percentile volume exceeds capacity, queue may be longer.  
Queue shown is maximum after two cycles.

# HCM Signalized Intersection Capacity Analysis

## 1: Pebble Beach/Highway 1 SB Off-ramp & Highway 1 SB On-ramp & Holman Hwy











3/7/2013

											
Movement	EBT	EBR	EBR2	WBL2	WBL	WBT	NBL	NBR	SBL2	SBT	SBR
Lane Configurations											
Volume (vph)	768	402	27	10	79	415	44	237	20	510	673
Ideal Flow (vphpl)	1900	1900	1900	1900	1900	1900	1900	1900	1900	1900	1900
Total Lost time (s)	4.0	4.0	4.0		4.0	4.0	4.0	4.0	4.0	4.0	4.0
Lane Util. Factor	1.00	1.00	1.00		1.00	1.00	1.00	1.00	1.00	1.00	1.00
Fr <sub>t</sub>	1.00	0.85	0.85		1.00	1.00	1.00	0.85	1.00	1.00	0.85
Fl <sub>t</sub> Protected	1.00	1.00	1.00		0.95	1.00	0.95	1.00	0.95	1.00	1.00
Satd. Flow (prot)	1863	1583	1583		1770	1863	1770	1583	1770	1863	1583
Fl <sub>t</sub> Permitted	1.00	1.00	1.00		0.95	1.00	0.95	1.00	0.95	1.00	1.00
Satd. Flow (perm)	1863	1583	1583		1770	1863	1770	1583	1770	1863	1583
Peak-hour factor, PHF	0.92	0.92	0.92	0.92	0.92	0.92	0.92	0.92	0.92	0.92	0.92
Adj. Flow (vph)	835	437	29	11	86	451	48	258	22	554	732
RTOR Reduction (vph)	0	0	0	0	0	0	0	0	0	0	0
Lane Group Flow (vph)	835	437	29	0	97	451	48	258	22	554	732
Turn Type	NA	Prot	Perm	Prot	Prot	NA	Prot	custom	Split	NA	Free
Protected Phases	4	4		3	3	8	5		6	6	
Permitted Phases			4					2			Free
Actuated Green, G (s)	39.1	39.1	39.1		5.0	48.1	3.1	33.1	26.0	26.0	89.2
Effective Green, g (s)	39.1	39.1	39.1		5.0	48.1	3.1	33.1	26.0	26.0	89.2
Actuated g/C Ratio	0.44	0.44	0.44		0.06	0.54	0.03	0.37	0.29	0.29	1.00
Clearance Time (s)	4.0	4.0	4.0		4.0	4.0	4.0	4.0	4.0	4.0	
Vehicle Extension (s)	3.0	3.0	3.0		3.0	3.0	3.0	3.0	3.0	3.0	
Lane Grp Cap (vph)	816	693	693		99	1004	61	587	515	543	1583
v/s Ratio Prot	c0.45	0.28			c0.05	0.24	0.03		0.01	c0.30	
v/s Ratio Perm			0.02					0.16			c0.46
v/c Ratio	1.02	0.63	0.04		0.98	0.45	0.79	0.44	0.04	1.02	0.46
Uniform Delay, d <sub>1</sub>	25.1	19.4	14.3		42.0	12.5	42.7	21.1	22.7	31.6	0.0
Progression Factor	1.00	1.00	1.00		1.00	1.00	1.00	1.00	1.00	1.00	1.00
Incremental Delay, d <sub>2</sub>	37.5	1.9	0.0		82.9	0.3	47.5	0.5	0.2	43.8	1.0
Delay (s)	62.6	21.3	14.4		125.0	12.8	90.2	21.6	22.8	75.4	1.0
Level of Service	E	C	B		F	B	F	C	C	E	A
Approach Delay (s)	47.7					32.7				32.9	
Approach LOS	D					C				C	
<b>Intersection Summary</b>											
HCM 2000 Control Delay			38.4			HCM 2000 Level of Service				D	
HCM 2000 Volume to Capacity ratio			1.02								
Actuated Cycle Length (s)			89.2			Sum of lost time (s)				16.0	
Intersection Capacity Utilization			88.9%			ICU Level of Service				E	
Analysis Period (min)			15								
c Critical Lane Group											

Queues

1: Pebble Beach/Highway 1 SB Off-ramp & Highway 1 SB On-ramp & Holman Hwy

3/7/2013

										
Lane Group	EBT	EBR	EBR2	WBL	WBT	NBL	NBR	SBL2	SBT	SBR
Lane Group Flow (vph)	835	437	29	97	451	48	258	22	554	732
v/c Ratio	1.01	0.63	0.04	0.97	0.45	0.60	0.45	0.04	1.01	0.46
Control Delay	62.1	24.4	15.0	129.0	14.3	73.9	24.0	23.5	74.5	1.0
Queue Delay	0.0	0.0	0.0	0.0	0.0	0.0	0.0	0.0	0.0	0.0
Total Delay	62.1	24.4	15.0	129.0	14.3	73.9	24.0	23.5	74.5	1.0
Queue Length 50th (ft)	~516	189	9	56	149	27	107	9	~340	0
Queue Length 95th (ft)	#739	294	25	#155	224	#82	175	27	#538	0
Internal Link Dist (ft)	908				497				387	
Turn Bay Length (ft)		200	200	200		50		200		
Base Capacity (vph)	823	698	698	100	1012	80	610	521	548	1583
Starvation Cap Reductn	0	0	0	0	0	0	0	0	0	0
Spillback Cap Reductn	0	0	0	0	0	0	0	0	0	0
Storage Cap Reductn	0	0	0	0	0	0	0	0	0	0
Reduced v/c Ratio	1.01	0.63	0.04	0.97	0.45	0.60	0.42	0.04	1.01	0.46

Intersection Summary

~ Volume exceeds capacity, queue is theoretically infinite.

Queue shown is maximum after two cycles.

# 95th percentile volume exceeds capacity, queue may be longer.





















Queue shown is maximum after two cycles.



# HCM Signalized Intersection Capacity Analysis

## 1: Pebble Beach/Highway 1 SB Off-ramp & Highway 1 SB On-ramp & Holman Hwy

3/7/2013

											
Movement	EBT	EBR	EBR2	WBL2	WBL	WBT	NBL	NBR	SBL2	SBT	SBR
Lane Configurations											
Volume (vph)	723	415	25	10	70	443	37	440	20	284	800
Ideal Flow (vphpl)	1900	1900	1900	1900	1900	1900	1900	1900	1900	1900	1900
Total Lost time (s)	4.0	4.0	4.0		4.0	4.0	4.0	4.0	4.0	4.0	4.0
Lane Util. Factor	1.00	1.00	1.00		1.00	1.00	1.00	1.00	1.00	1.00	1.00
Fr <sub>t</sub>	1.00	0.85	0.85		1.00	1.00	1.00	0.85	1.00	1.00	0.85
Fl <sub>t</sub> Protected	1.00	1.00	1.00		0.95	1.00	0.95	1.00	0.95	1.00	1.00
Satd. Flow (prot)	1863	1583	1583		1770	1863	1770	1583	1770	1863	1583
Fl <sub>t</sub> Permitted	1.00	1.00	1.00		0.95	1.00	0.95	1.00	0.95	1.00	1.00
Satd. Flow (perm)	1863	1583	1583		1770	1863	1770	1583	1770	1863	1583
Peak-hour factor, PHF	0.92	0.92	0.92	0.92	0.92	0.92	0.92	0.92	0.92	0.92	0.92
Adj. Flow (vph)	786	451	27	11	76	482	40	478	22	309	870
RTOR Reduction (vph)	0	0	0	0	0	0	0	0	0	0	0
Lane Group Flow (vph)	786	451	27	0	87	482	40	478	22	309	870
Turn Type	NA	Prot	Perm	Prot	Prot	NA	Prot	custom	Split	NA	Free
Protected Phases	4	4		3	3	8	5		6	6	
Permitted Phases			4					2			Free
Actuated Green, G (s)	34.9	34.9	34.9		4.0	42.9	2.3	27.7	21.4	21.4	78.6
Effective Green, g (s)	34.9	34.9	34.9		4.0	42.9	2.3	27.7	21.4	21.4	78.6
Actuated g/C Ratio	0.44	0.44	0.44		0.05	0.55	0.03	0.35	0.27	0.27	1.00
Clearance Time (s)	4.0	4.0	4.0		4.0	4.0	4.0	4.0	4.0	4.0	
Vehicle Extension (s)	3.0	3.0	3.0		3.0	3.0	3.0	3.0	3.0	3.0	
Lane Grp Cap (vph)	827	702	702		90	1016	51	557	481	507	1583
v/s Ratio Prot	c0.42	0.28			0.05	0.26	0.02		0.01	0.17	
v/s Ratio Perm			0.02					c0.30			c0.55
v/c Ratio	0.95	0.64	0.04		0.97	0.47	0.78	0.86	0.05	0.61	0.55
Uniform Delay, d <sub>1</sub>	21.0	17.0	12.4		37.2	10.9	37.9	23.6	21.1	25.0	0.0
Progression Factor	1.00	1.00	1.00		1.00	1.00	1.00	1.00	1.00	1.00	1.00
Incremental Delay, d <sub>2</sub>	20.2	2.0	0.0		83.1	0.4	53.8	12.4	0.2	5.4	1.4
Delay (s)	41.2	19.0	12.4		120.3	11.3	91.7	36.1	21.3	30.3	1.4
Level of Service	D	B	B		F	B	F	D	C	C	A
Approach Delay (s)	32.7					28.0				9.2	
Approach LOS	C					C				A	
<b>Intersection Summary</b>											
HCM 2000 Control Delay			25.1			HCM 2000 Level of Service				C	
HCM 2000 Volume to Capacity ratio			0.98								
Actuated Cycle Length (s)			78.6			Sum of lost time (s)				16.0	
Intersection Capacity Utilization			86.4%			ICU Level of Service				E	
Analysis Period (min)			15								
c Critical Lane Group											

# Queues

## 1: Pebble Beach/Highway 1 SB Off-ramp & Highway 1 SB On-ramp & Holman Hwy

3/7/2013

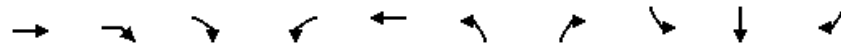

Lane Group	EBT	EBR	EBR2	WBL	WBT	NBL	NBR	SBL2	SBT	SBR
Lane Group Flow (vph)	786	451	27	87	482	40	478	22	309	870
v/c Ratio	0.93	0.63	0.04	0.95	0.46	0.43	0.89	0.04	0.60	0.55
Control Delay	40.7	21.4	12.6	122.7	12.4	52.2	45.9	23.1	31.1	1.4
Queue Delay	0.0	0.0	0.0	0.0	0.0	0.0	0.0	0.0	0.0	0.0
Total Delay	40.7	21.4	12.6	122.7	12.4	52.2	45.9	23.1	31.1	1.4
Queue Length 50th (ft)	359	166	7	45	135	20	219	8	139	0
Queue Length 95th (ft)	#599	267	21	#134	209	#58	#391	26	224	0
Internal Link Dist (ft)	908					497			387	
Turn Bay Length (ft)		200	200	200		50		200		
Base Capacity (vph)	877	745	745	92	1072	92	579	492	517	1583
Starvation Cap Reductn	0	0	0	0	0	0	0	0	0	0
Spillback Cap Reductn	0	0	0	0	0	0	0	0	0	0
Storage Cap Reductn	0	0	0	0	0	0	0	0	0	0
Reduced v/c Ratio	0.90	0.61	0.04	0.95	0.45	0.43	0.83	0.04	0.60	0.55

### Intersection Summary

# 95th percentile volume exceeds capacity, queue may be longer.  
 Queue shown is maximum after two cycles.

Attachment E  
Roundabout Operations  
Analysis

# MOVEMENT SUMMARY

Site: AM 2015 + Alt 1\_Interim  
Configuration

Holman Hwy / Hwy 1 SB Ramp Intersection  
Dual Roundabout Concept  
Layout 1: Interim  
Roundabout

Movement Performance - Vehicles												
Mov ID	Turn	Demand Flow veh/h	HV %	Deg. Satn v/c	Average Delay sec	Level of Service	95% Back of Queue Vehicles veh	Distance ft	Prop. Queued	Effective Stop Rate per veh	Average Speed mph	
South: NB Pebble Beach												
3	L	49	2.3	0.121	13.3	LOS B	0.4	11.0	0.60	0.86	17.5	
18	R	241	2.3	0.333	5.2	LOS A	1.6	41.1	0.67	0.59	20.3	
Approach		290	2.3	0.333	6.6	LOS A	1.6	41.1	0.66	0.64	19.6	
East: WB Holman Hwy												
1	L	99	2.3	0.455	9.8	LOS A	2.6	65.2	0.21	0.87	26.6	
6	T	418	2.3	0.455	4.2	LOS A	2.6	65.2	0.21	0.37	31.1	
Approach		517	2.3	0.455	5.3	LOS A	2.6	65.2	0.21	0.46	30.1	
North: SB Off-Ramp												
7	L	22	2.3	0.713	28.2	LOS D	7.5	192.0	0.87	1.11	26.9	
4	T	511	2.3	0.713	23.5	LOS C	7.5	192.0	0.87	1.06	28.7	
14	R	686	2.3	0.433	12.5	X	X	X	X	0.67	42.0	
Approach		1219	2.3	0.713	17.4	LOS C	7.5	192.0	0.38	0.84	36.4	
West: EB Holman Hwy												
2	T	764	2.3	0.800	16.7	LOS C	11.8	300.6	0.96	1.14	26.5	
12	R	433	2.3	0.536	10.3	LOS B	4.7	120.5	0.87	0.91	29.2	
Approach		1198	2.3	0.800	14.4	LOS B	11.8	300.6	0.93	1.06	27.3	
All Vehicles		3223	2.3	0.800	13.4	LOS B	11.8	300.6	0.58	0.84	30.5	

X: Not applicable for Continuous movement.

Level of Service (LOS) Method: Delay (HCM 2000).

Roundabout LOS Method: Same as Sign Control.

Vehicle movement LOS values are based on average delay per movement

Intersection and Approach LOS values are based on average delay for all vehicle movements.

Roundabout Capacity Model: SIDRA Standard.

SIDRA Standard Delay Model used.

# MOVEMENT SUMMARY

Site: PM 2015 + Alt 1\_Interim  
Configuration

Holman Hwy / Hwy 1 SB Ramp Intersection  
Dual Roundabout Concept  
Layout 1: Interim  
Roundabout

Movement Performance - Vehicles											
Mov ID	Turn	Demand Flow veh/h	HV %	Deg. Satn v/c	Average Delay sec	Level of Service	95% Back of Queue Vehicles veh	Distance ft	Prop. Queued	Effective Stop Rate per veh	Average Speed mph
South: NB Pebble Beach											
3	L	40	0.6	0.085	12.6	LOS B	0.3	6.9	0.53	0.83	17.9
18	R	435	0.6	0.519	5.8	LOS A	3.0	74.4	0.67	0.71	20.3
Approach		475	0.6	0.519	6.4	LOS A	3.0	74.4	0.66	0.72	20.0
East: WB Holman Hwy											
1	L	87	0.6	0.441	9.7	LOS A	2.4	60.2	0.18	0.90	26.6
6	T	427	0.6	0.441	4.1	LOS A	2.4	60.2	0.18	0.36	31.5
Approach		514	0.6	0.441	5.1	LOS A	2.4	60.2	0.18	0.45	30.4
North: SB Off-Ramp											
7	L	11	0.6	0.367	22.1	LOS C	2.1	51.6	0.66	0.96	31.1
4	T	276	0.6	0.367	17.5	LOS C	2.1	51.6	0.66	0.83	34.5
14	R	793	0.6	0.495	12.4	X	X	X	X	0.67	42.0
Approach		1080	0.6	0.495	13.8	LOS B	2.1	51.6	0.18	0.71	40.3
West: EB Holman Hwy											
2	T	703	0.6	0.541	7.8	LOS A	4.3	108.8	0.68	0.67	31.0
12	R	436	0.6	0.405	7.0	LOS A	2.7	68.7	0.61	0.63	30.5
Approach		1139	0.6	0.541	7.5	LOS A	4.3	108.8	0.65	0.66	30.8
All Vehicles		3209	0.6	0.541	9.1	LOS A	4.3	108.8	0.42	0.65	33.0

X: Not applicable for Continuous movement.

Level of Service (LOS) Method: Delay (HCM 2000).

Roundabout LOS Method: Same as Sign Control.

Vehicle movement LOS values are based on average delay per movement

Intersection and Approach LOS values are based on average delay for all vehicle movements.

Roundabout Capacity Model: SIDRA Standard.

SIDRA Standard Delay Model used.

# MOVEMENT SUMMARY

Site: AM 2030 + Alt 1\_Interim Configuration

Holman Hwy / Hwy 1 SB Ramp Intersection  
 Dual Roundabout Concept  
 Layout 1: Interim Roundabout

Movement Performance - Vehicles											
Mov ID	Turn	Demand Flow veh/h	HV %	Deg. Satn v/c	Average Delay sec	Level of Service	95% Back of Queue Vehicles veh	Distance ft	Prop. Queued	Effective Stop Rate per veh	Average Speed mph
South: NB Pebble Beach											
3	L	49	2.3	0.075	6.3	LOS A	0.3	7.9	0.67	0.85	16.3
18	R	263	2.3	0.368	9.8	LOS A	1.8	44.6	0.72	0.85	15.7
Approach		312	2.3	0.368	9.2	LOS A	1.8	44.6	0.71	0.85	15.8
East: WB Holman Hwy											
1	L	99	2.3	0.418	6.7	LOS A	2.9	72.6	0.24	0.86	22.6
6	T	461	2.3	0.418	6.7	LOS A	2.9	72.6	0.24	0.36	25.7
Approach		560	2.3	0.418	6.7	LOS A	2.9	72.6	0.24	0.45	25.1
North: SB Off-Ramp											
7	L	22	2.3	0.780	23.4	LOS C	8.0	202.5	0.93	1.15	20.0
4	T	567	2.3	0.780	23.4	LOS C	8.0	202.5	0.93	1.12	20.2
14	R	748	2.3	0.472	0.1	X	X	X	X	0.67	42.0
Approach		1337	2.3	0.780	10.4	LOS B	8.0	202.5	0.41	0.87	30.9
West: EB Holman Hwy											
2	T	853	2.3	0.900	30.5	LOS D	12.6	320.7	0.91	1.27	19.2
12	R	477	2.3	0.669	18.0	LOS C	5.2	131.3	0.85	1.05	22.0
Approach		1330	2.3	0.900	26.0	LOS D	12.6	320.7	0.89	1.19	20.0
All Vehicles		3539	2.3	0.900	15.6	LOS C	12.6	320.7	0.59	0.92	23.9

X: Not applicable for Continuous movement.

Level of Service (LOS) Method: Delay & v/c (HCM 2010).

Roundabout LOS Method: Same as Sign Control.

Vehicle movement LOS values are based on average delay and v/c ratio (degree of saturation) per movement

LOS F will result if v/c > 1 irrespective of movement delay value (does not apply for approaches and intersection).

Intersection and Approach LOS values are based on average delay for all movements (v/c not used as specified in HCM 2010).

Roundabout Capacity Model: US HCM 2010.

HCM Delay Model used.

# MOVEMENT SUMMARY

Site: PM 2030 + Alt 1\_Interim Configuration

Holman Hwy / Hwy 1 SB Ramp Intersection  
Dual Roundabout Concept  
Layout 1: Interim Roundabout

Movement Performance - Vehicles												
Mov ID	Turn	Demand Flow veh/h	HV %	Deg. Satn v/c	Average Delay sec	Level of Service	95% Back of Queue Vehicles veh	Distance ft	Prop. Queued	Effective Stop Rate per veh	Average Speed mph	
South: NB Pebble Beach												
3	L	41	0.6	0.058	5.7	LOS A	0.2	6.2	0.65	0.81	16.6	
18	R	489	0.6	0.633	15.5	LOS C	4.6	116.1	0.84	1.07	12.7	
Approach		530	0.6	0.633	14.8	LOS B	4.6	116.1	0.83	1.05	13.0	
East: WB Holman Hwy												
1	L	89	0.6	0.423	6.6	LOS A	3.0	75.6	0.22	0.88	22.6	
6	T	492	0.6	0.423	6.6	LOS A	3.0	75.6	0.22	0.36	25.8	
Approach		581	0.6	0.423	6.6	LOS A	3.0	75.6	0.22	0.44	25.2	
North: SB Off-Ramp												
7	L	22	0.6	0.441	10.6	LOS B	2.5	61.9	0.72	1.04	26.0	
4	T	316	0.6	0.441	10.6	LOS B	2.5	61.9	0.72	0.93	28.0	
14	R	889	0.6	0.554	0.2	X	X	X	X	0.67	41.9	
Approach		1227	0.6	0.554	3.0	LOS A	2.5	61.9	0.20	0.74	38.1	
West: EB Holman Hwy												
2	T	803	0.6	0.633	11.5	LOS B	5.4	136.4	0.73	0.86	26.6	
12	R	489	0.6	0.513	10.3	LOS B	3.5	87.0	0.69	0.80	25.9	
Approach		1292	0.6	0.633	11.0	LOS B	5.4	136.4	0.71	0.84	26.3	
All Vehicles		3630	0.6	0.633	8.2	LOS A	5.4	136.4	0.48	0.77	28.2	

X: Not applicable for Continuous movement.

Level of Service (LOS) Method: Delay & v/c (HCM 2010).

Roundabout LOS Method: Same as Sign Control.

Vehicle movement LOS values are based on average delay and v/c ratio (degree of saturation) per movement

LOS F will result if v/c > 1 irrespective of movement delay value (does not apply for approaches and intersection).

Intersection and Approach LOS values are based on average delay for all movements (v/c not used as specified in HCM 2010).

Roundabout Capacity Model: US HCM 2010.

HCM Delay Model used.

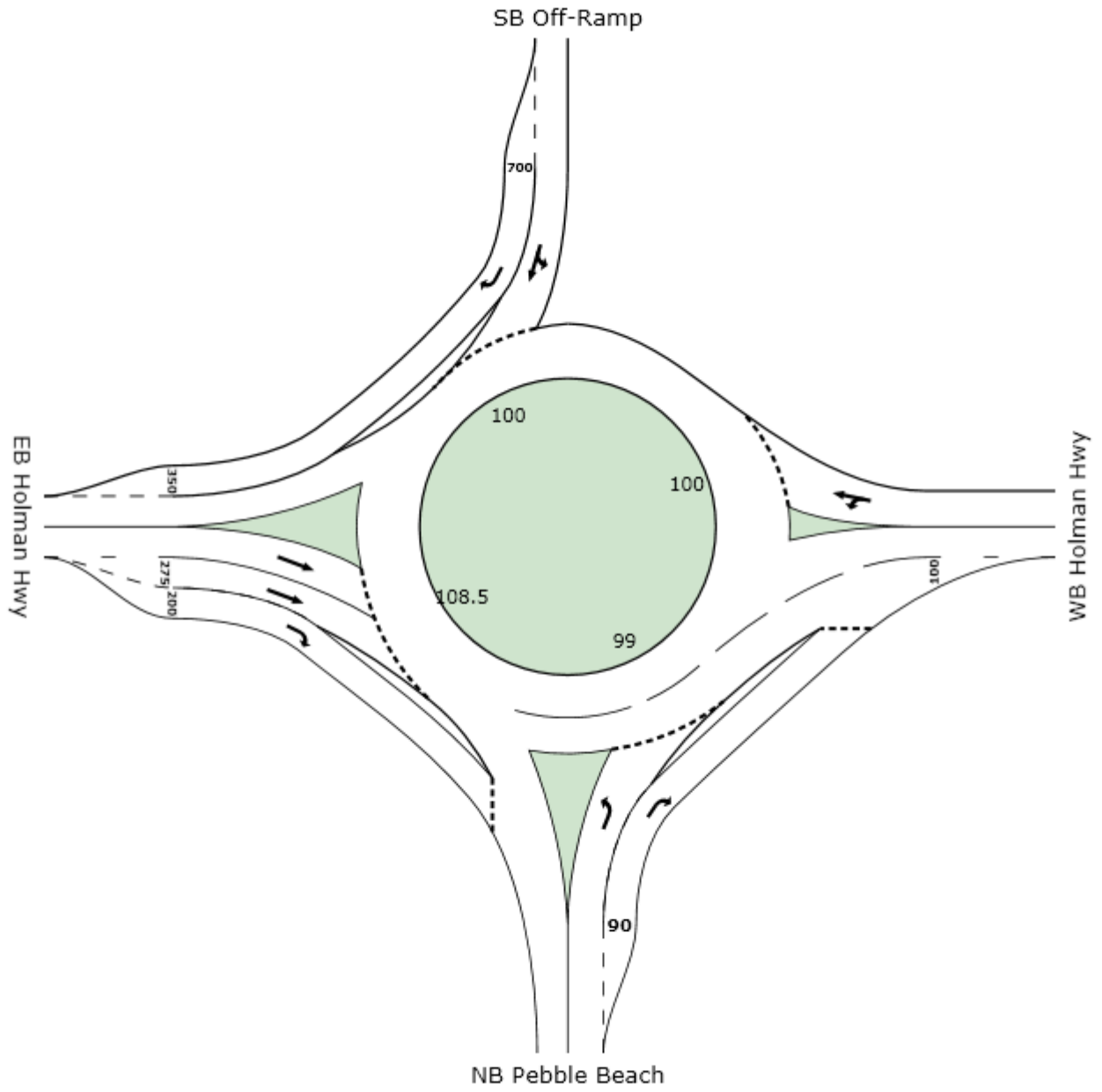



Attachment F  
Guide Signing Concepts

# ROUNDABOUT GUIDE SIGNING CONCEPT 2015 Interim Condition

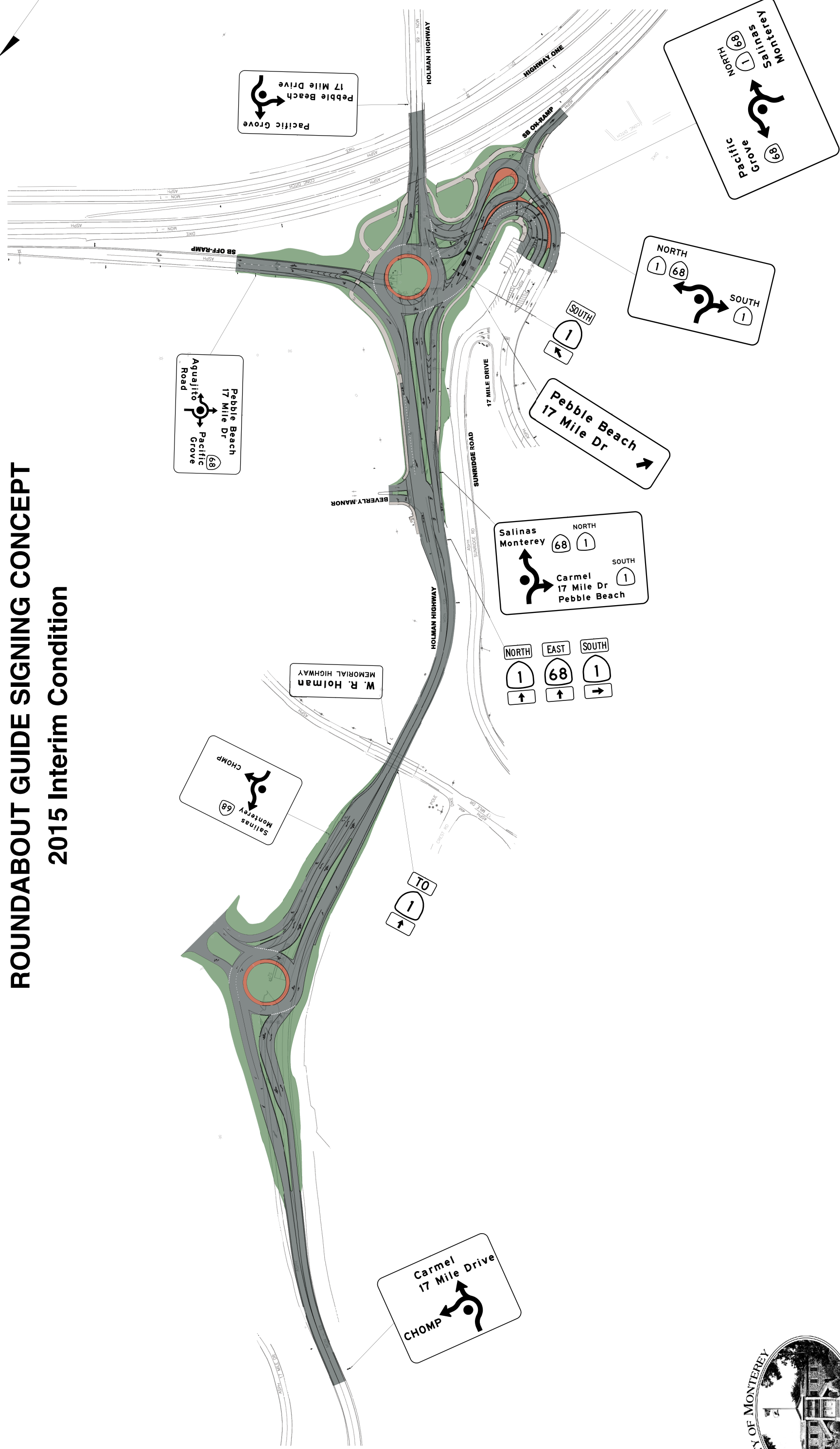

# TRAFFIC SIGNAL GUIDE SIGNING CONCEPT

## 2015 Interim Condition

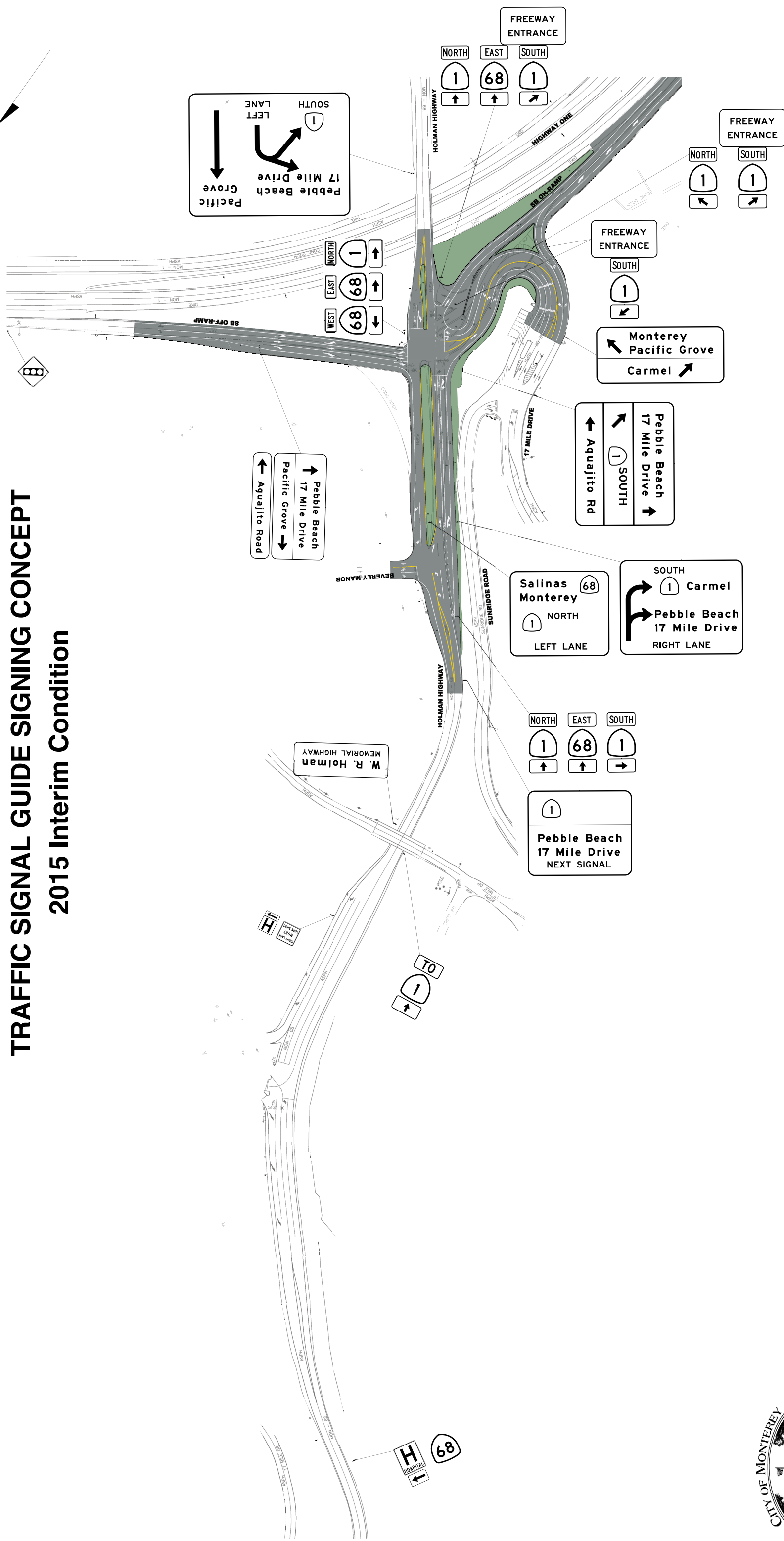

Attachment G  
Design Vehicle Checks



# TRUCK TURNING MOVEMENT Northbound Right-Turn from Pebble Beach

SCALE: 1" = 40'

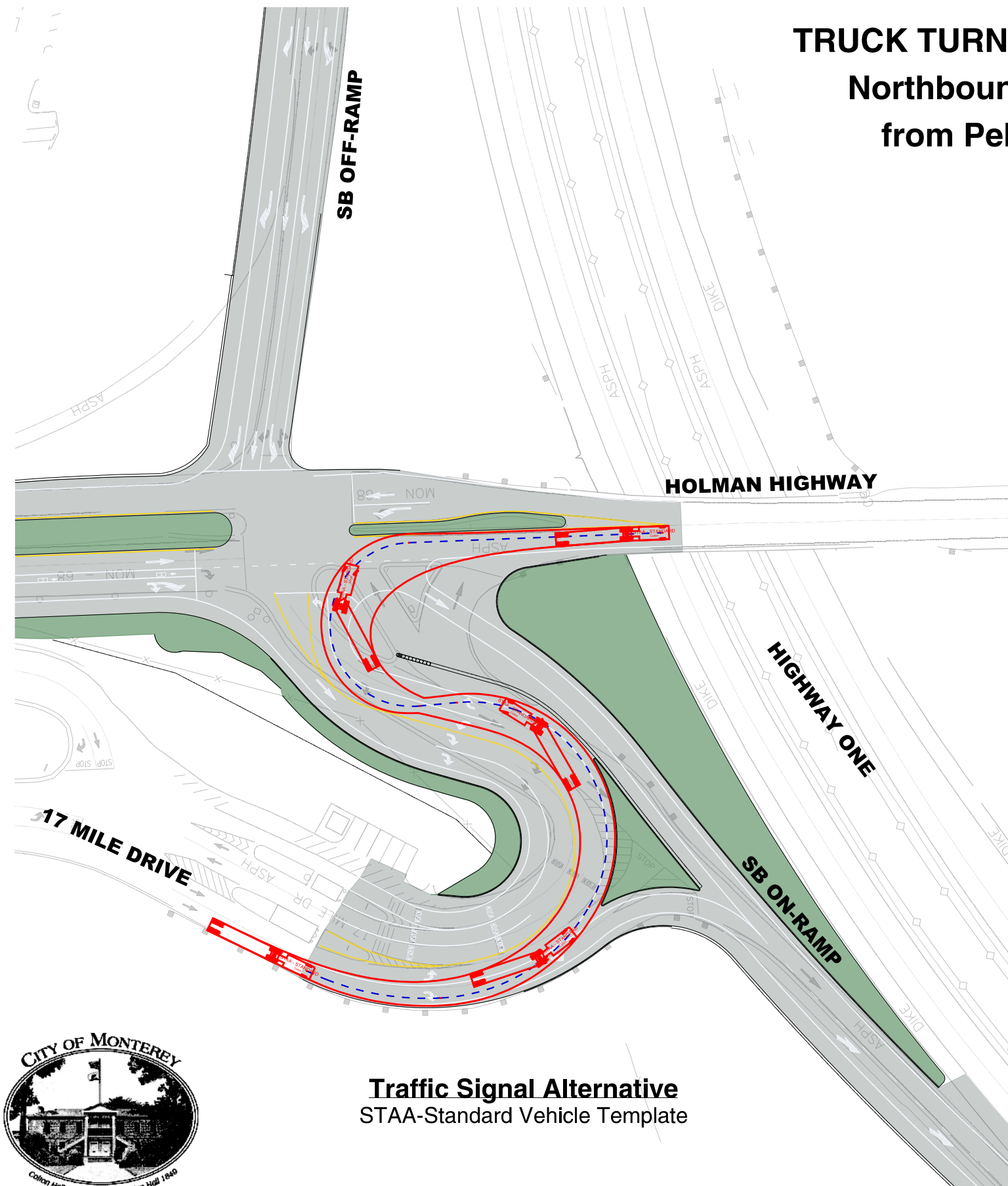

**Traffic Signal Alternative**  
STAA-Standard Vehicle Template

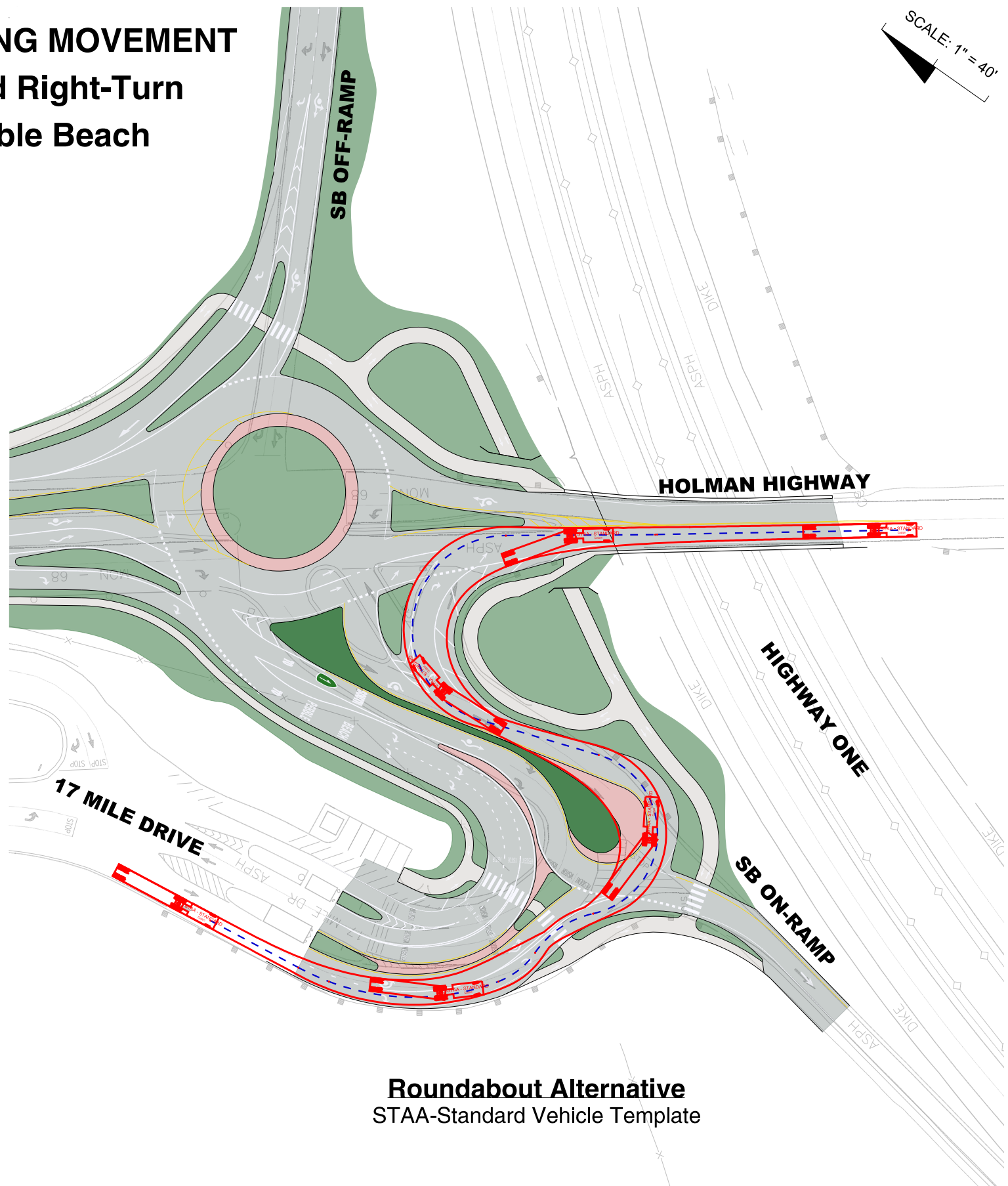

**Roundabout Alternative**  
STAA-Standard Vehicle Template



\$(getvar, "dwgprefix")\$(getvar, "dwgname") \$(edtime, 0, MON DD"; "YYYY - H:MMam/pm) - \$(getvar, "loginname") Layout Tab: \$(getvar, "ctab")

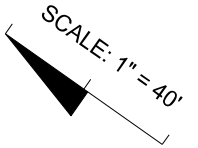

# TRUCK TURNING MOVEMENT Southbound Ramp to Southbound Ramp

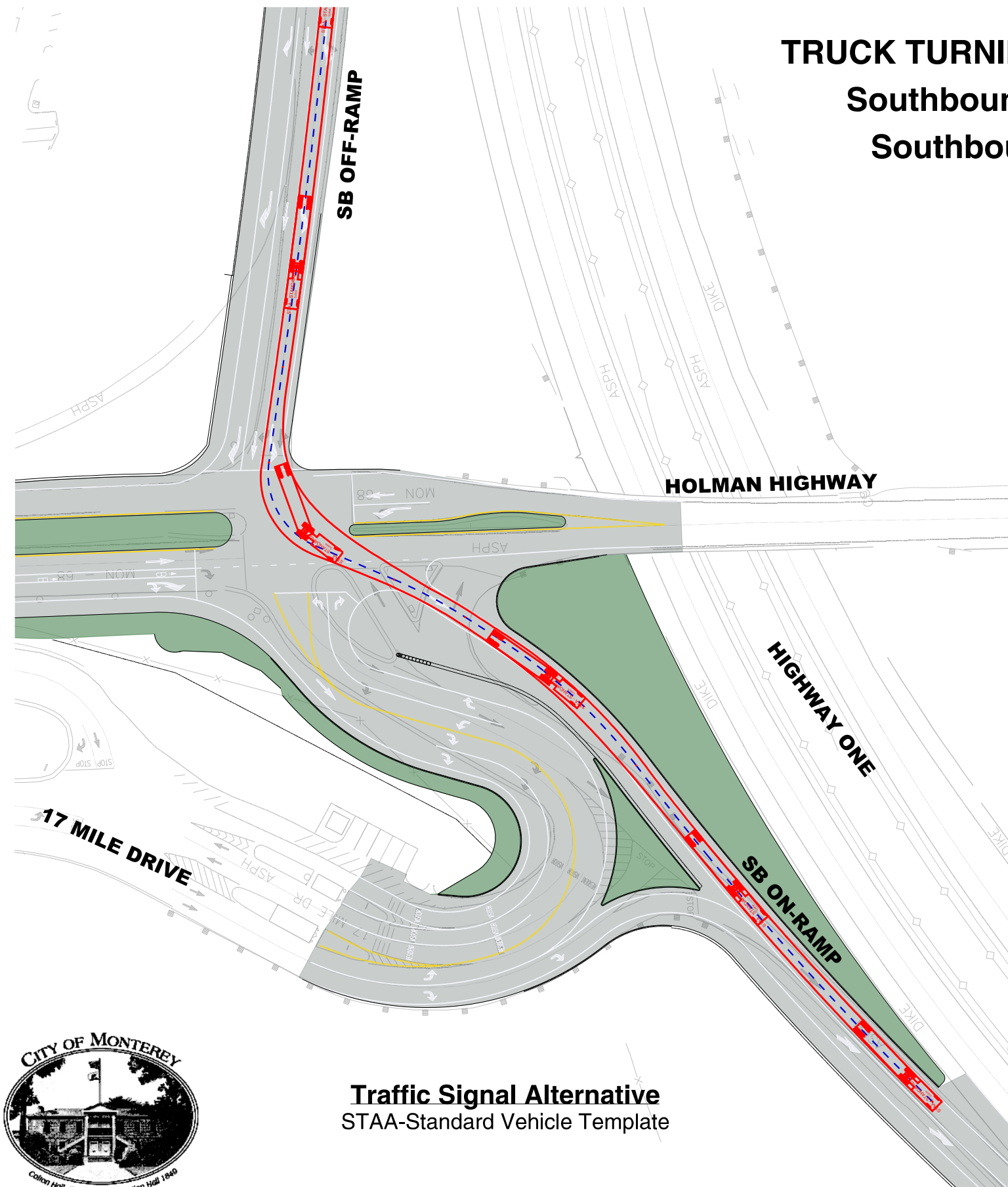

**Traffic Signal Alternative**  
STAA-Standard Vehicle Template

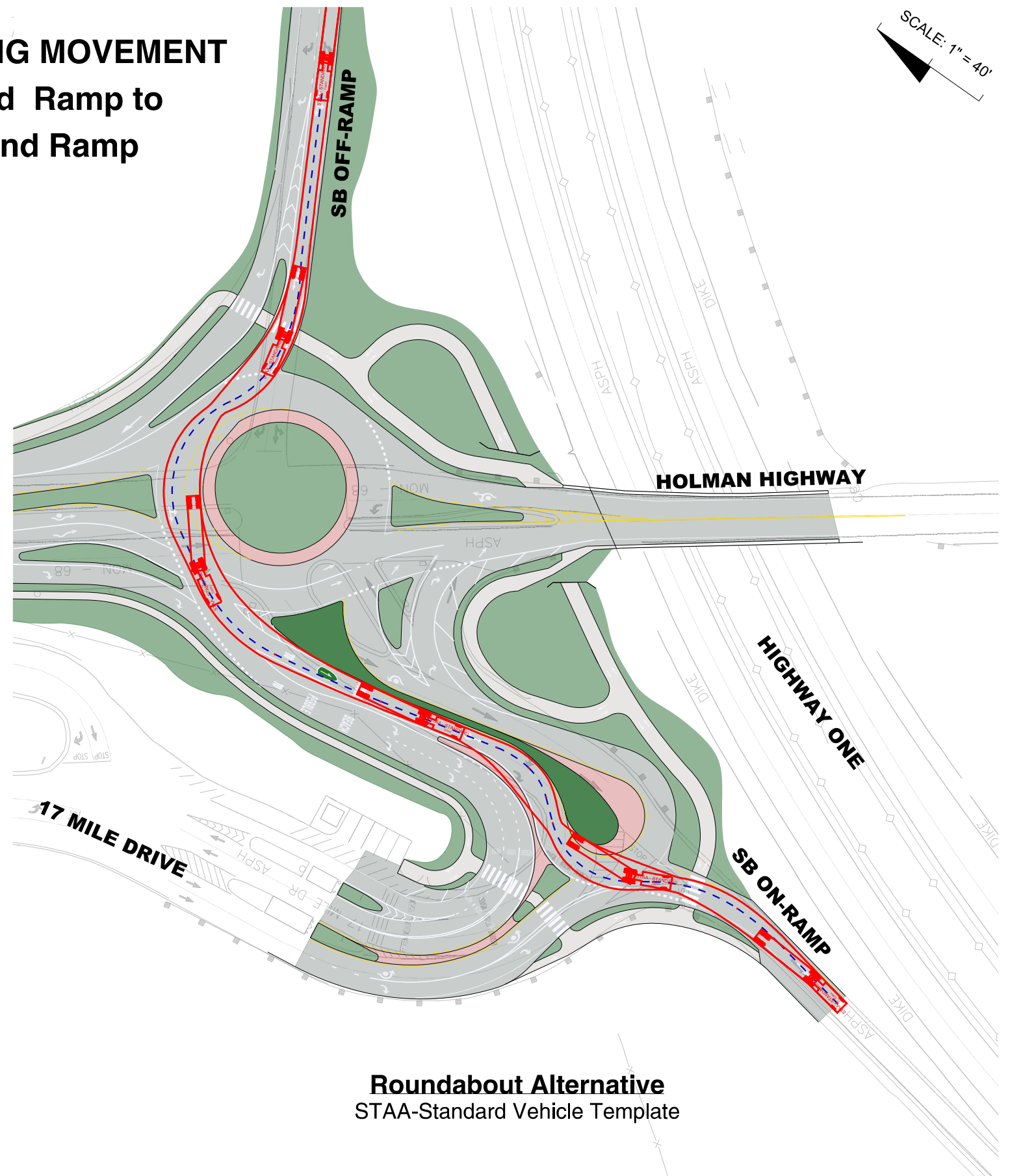

**Roundabout Alternative**  
STAA-Standard Vehicle Template

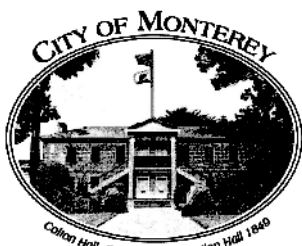

S:\getvar, "dwgprefix"\S\getvar, "dwgname" - \$(edtime, 0, MON DD) - "YYYY - H:MMam/pm) - \$(getvar, "loginname") Layout Tab: \$(getvar, "ctab")



# TRUCK TURNING MOVEMENT Westbound Left-Turn to Pebble Beach

SCALE: 1" = 40'

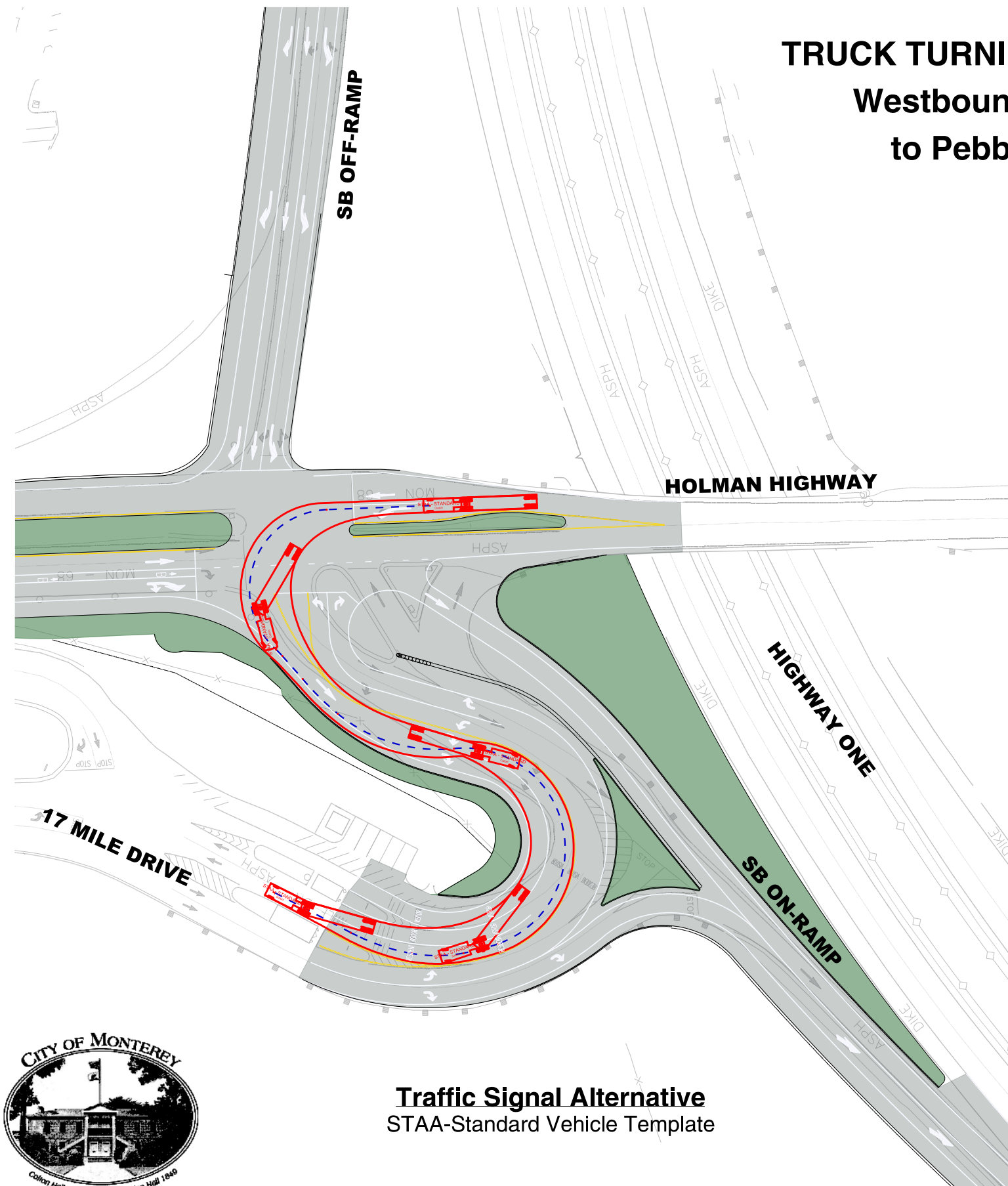

**Traffic Signal Alternative**  
STAA-Standard Vehicle Template

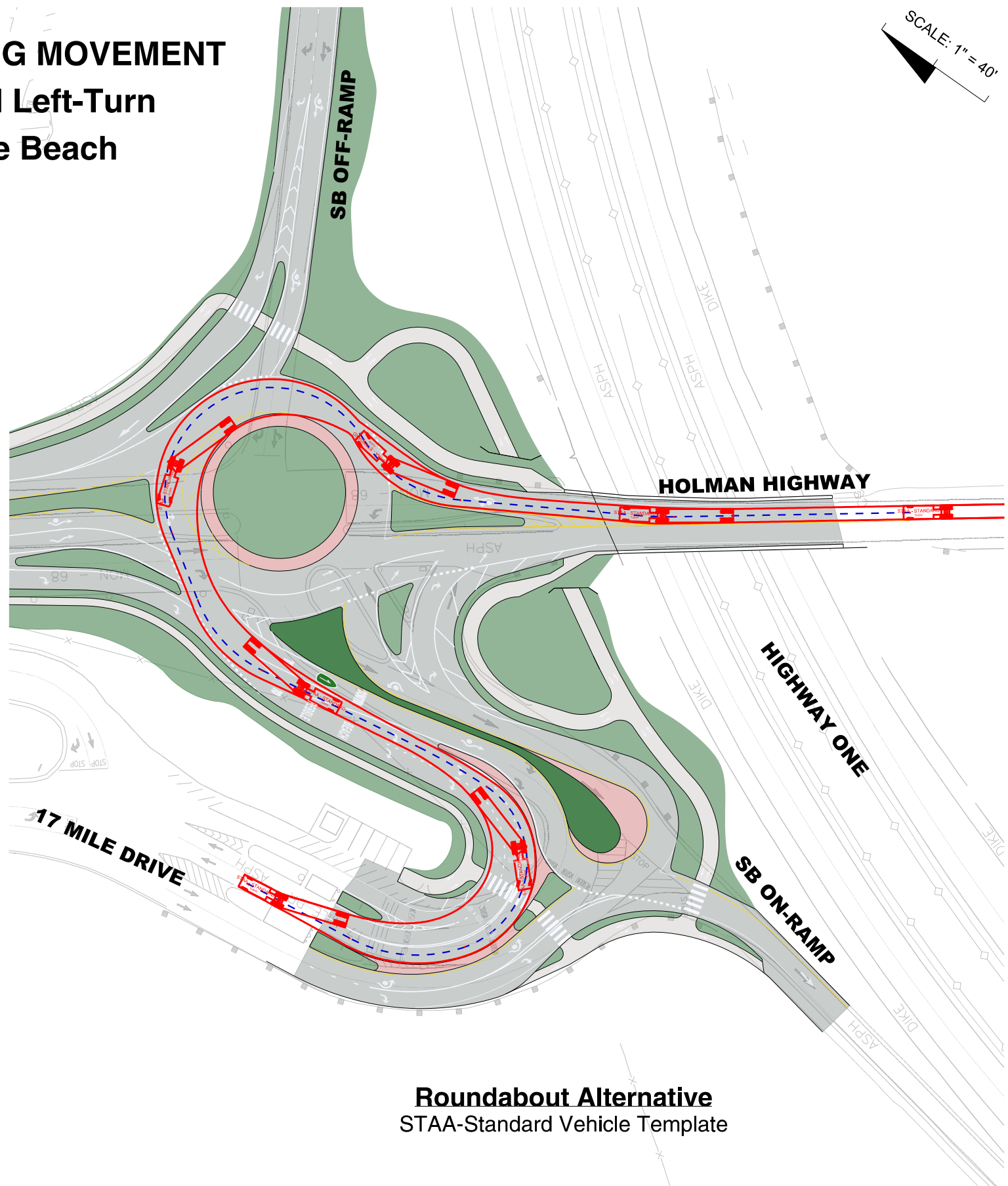

**Roundabout Alternative**  
STAA-Standard Vehicle Template



\$(getvar, "dwgprefix")\$(getvar, "dwgname") \$(edtime, 0, MON DD"; "YYYY - H:MMam/pm) - \$(getvar, "loginname") Layout Tab: \$(getvar, "ctab")

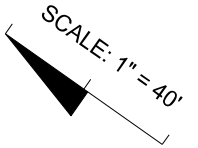

# TRUCK TURNING MOVEMENT Westbound Left-Turn to Southbound Ramp

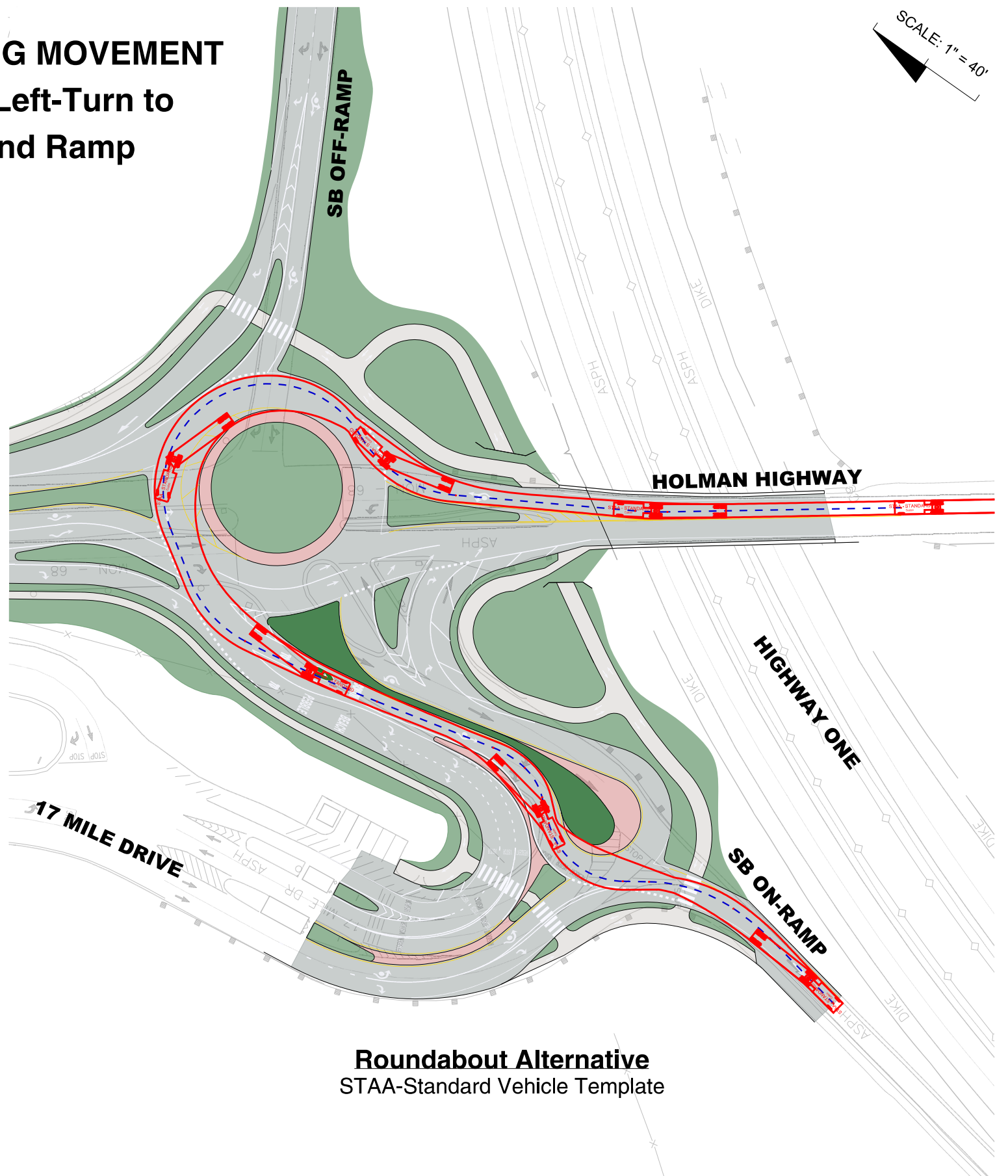
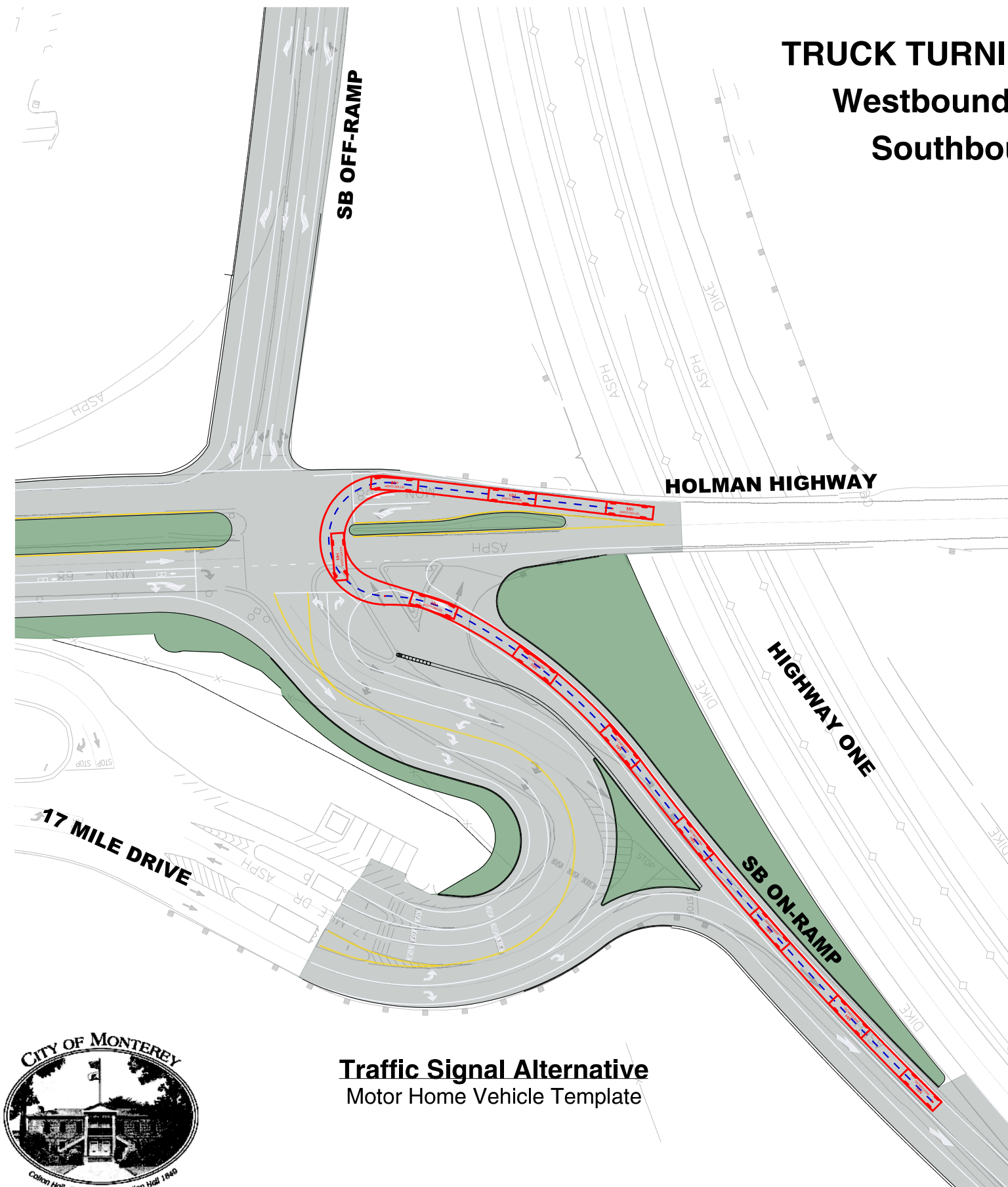

\$(getvar, "dwgprefix")\$(getvar, "dwgname") \$(edtime, 0, MON DD"; "YYYY - H:MMam/pm) - \$(getvar, "loginname")  
 Layout Tab: \$(getvar, "ctab")